

NORD-LOCK®

NORD-LOCK is a superior bolt securing system that provides safe locking for bolted joints even when exposed to severe vibration and dynamic load.

- Makes the bolt self-locking
- Facilitates maintenance work
- Controllable preload
- No special tools required
- Reusable

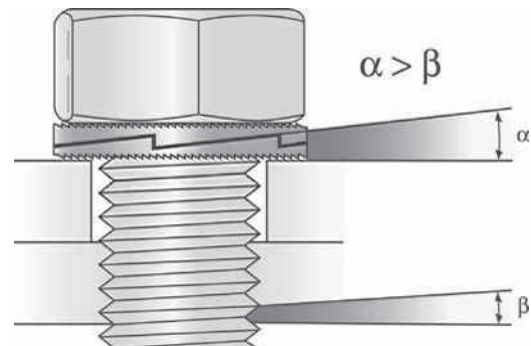

NORD-LOCK consists of a pair of washers with a wedge-locking action meeting DIN 25201 which is a unique method using tension instead of friction. The rise of the cams between the NORD-LOCK washers is greater than the pitch of the bolt. In addition, there are radial teeth on the opposite side. The washers are installed in pairs, cam face to cam face.

7

When the bolt and/or nut is tightened the teeth grip and seat the mating surfaces. The NORD-LOCK washer is locked in place, allowing movement only across the face of the cams. Any attempt from the bolt/nut to rotate loose is blocked by the wedge effect of the cams.



Here you see what happens when a bolt is untightened with a wrench. The pair of washers expand more than the corresponding pitch of the thread allows the bolt/nut to rise.

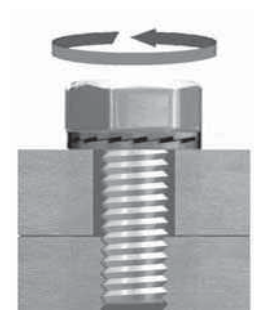

Vibration proof washer

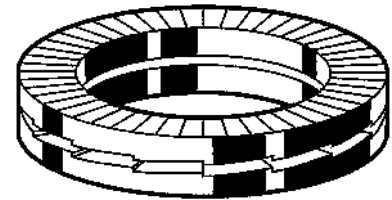
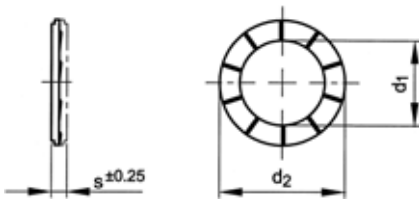

Technical data

For nom.size	d ₁	d ₂	s (Set)
M3	3,4	7	1,8
M4	4,4	7,6	1,8
M5	5,4	9	1,8
M6	6,5	10,8	1,8
M8	8,7	13,5	2,5
M10	10,7	16,6	2,5
M12	13	19,5	2,5
M14	15,2	23	3,4
M16	17	25,4	3,4
M18	19,5	29	3,4
M20	21,4	30,7	3,4
M22	23,4	34,5	3,4
M24	25,3	39	3,4
M27	28,4	42	6,6
M30	31,4	47	6,6
M33	34,4	48,5	6,6
M36	37,4	55	6,6
M42	43,2	63	6,6

- For general information concerning NORD-LOCK vibration proof fasteners, see INFO-page.

Article groups

Material	Surface treatment	Packaging	Code	Page
St	Del pro	Standard	37980	7-83
St	Del pro	Self service	37985	7-83

37980	NORD-LOCK Vibration proof washer 2 pieces	L07A
Material	Steel	 
Surface treatment	Deltaprotekt	
Packaging	Standard	

For nom. size	☒	Art.number	For nom. size	☒	Art.number	For nom. size	☒	Art.number
M3	200	37980.030.001	M12	200	37980.120.001	M24	100	37980.240.001
M4	200	37980.040.001	M14	100	37980.140.001	M27	50	37980.270.001
M5	200	37980.050.001	M16	100	37980.160.001	M30	50	37980.300.001
M6	200	37980.060.001	M18	100	37980.180.001	M33	25	37980.330.001
M8	200	37980.080.001	M20	100	37980.200.001	M36	25	37980.360.001
M10	200	37980.100.001	M22	100	37980.220.001	M42	25	37980.420.001

- Technical brochure available on request.

37985	NORD-LOCK Vibration proof washer 2 pieces	Y09A
Material	Steel	 
Surface treatment	Deltaprotekt	
Packaging	Self service	

For nom. size	☒	Art.number	For nom. size	☒	Art.number	For nom. size	☒	Art.number
M6(25PC)	1	37985.060.001	M10(25PC)	1	37985.100.001	M16(10PC)	1	37985.160.001
M8(25PC)	1	37985.080.001	M12(10PC)	1	37985.120.001	M20(10PC)	1	37985.200.001

- Technical brochure available on request.

Vibration proof washer St.st.

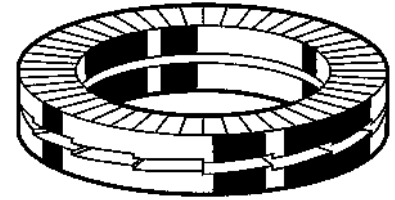
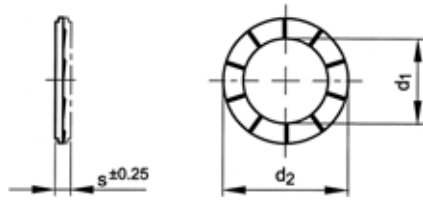

Technical data

For nom.size	d ₁	d ₂	s (Set)
M3	3,4	7	2,2
M4	4,4	7,6	2,2
M5	5,4	9	2,2
M6	6,5	10,8	2,2
M8	8,7	13,5	2,2
M10	10,7	16,6	2,2
M12	13	19,5	2,2
M16	17	25,4	3,2
M18	19,5	29	3,2
M20	21,4	30,7	3,2
M22	23,4	34,5	3,2
M24	25,3	39	3,2
M27	28,4	42	6,8
M30	31,4	47	6,8
M33	34,4	48,5	6,8
M36	37,4	55	6,8
M39	40,4	58,5	6,8
M42	43,2	63	6,8

- For general information concerning NORD-LOCK vibration proof fasteners, see INFO-page.
- Technical brochure available on request.

Article groups

Material	Packaging	Code	Page
St.St. A4	Standard	55437	7-84
St.St. A4	Self service	55436	7-84

7

55437 NORD-LOCK Vibration proof washer R47A

Material Stainless steel A4
Packaging Standard



For nom. size	☒	Art.number	For nom. size	☒	Art.number	For nom. size	☒	Art.number
M3	200	55437.030.001	M12	200	55437.120.001	M27	50	55437.270.001
M4	200	55437.040.001	M16	100	55437.160.001	M30	50	55437.300.001
M5	200	55437.050.001	M18	100	55437.180.001	M33	25	55437.330.001
M6	200	55437.060.001	M20	100	55437.200.001	M36	25	55437.360.001
M8	200	55437.080.001	M22	100	55437.220.001	M39	25	55437.390.001
M10	200	55437.100.001	M24	100	55437.240.001	M42	25	55437.420.001

55436 NORD-LOCK Vibration proof washer Y09A

Material Stainless steel A4
Packaging Self service



For nom. size	☒	Art.number	For nom. size	☒	Art.number	For nom. size	☒	Art.number
M6(10PC)	1	55436.060.001	M10(10PC)	1	55436.100.001	M16(5PC)	1	55436.160.001
M8(10PC)	1	55436.080.001	M12(5PC)	1	55436.120.001	M20(5PC)	1	55436.200.001

Vibration proof washer large outside diameter

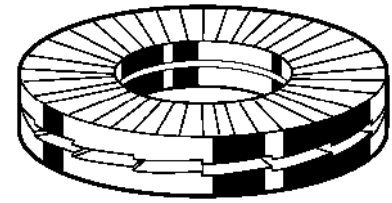
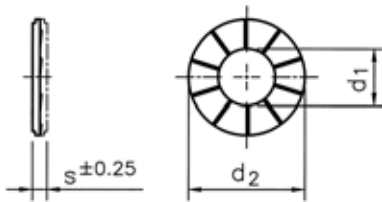

Technical data

For nom.size	d ₁	d ₂	s (Set)
M4	4,4	9	1,8
M5	5,4	10,8	1,8
M6	6,5	13,5	2,5
M8	8,7	16,6	2,5
M10	10,7	21	2,5
M12	13	25,4	3,4
M14	15,2	30,7	3,4
M16	17	30,7	3,4
M18	19,5	34,5	3,4
M20	21,4	39	3,4
M22	23,4	42	4,6
M24	25,3	48,5	4,6
M27	28,4	48,5	6,6
M30	31,4	58,5	6,6
M33	34,4	58,5	6,6
M36	37,4	63	6,6

- For general information concerning NORD-LOCK vibration proof fasteners, see INFO-page.
- Vibration proof washers with large outside diameter are recommended for oversize and elongated holes, where a larger contact surface is required.
- Technical brochure available on request.

Article groups

Material	Surface treatment	Packaging	Code	Page
St	Del pro	Standard	37982	7-85
St	Del pro	Self service	37986	7-85

37982 NORD-LOCK Vibration proof washers large outside diameter

L07A

Material: Steel
 Surface treatment: Deltaprotekt
 Packaging: Standard

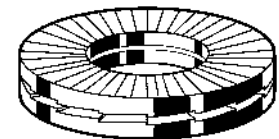

For nom. size x d2	☒	Art.number	For nom. size x d2	☒	Art.number	For nom. size x d2	☒	Art.number
M4X9	200	37982.040.009	M14X30,7	100	37982.140.030	M27X48,5	25	37982.270.048
M5X10,8	200	37982.050.010	M16X30,7	100	37982.160.030	M30X58,5	25	37982.300.058
M6X13,5	200	37982.060.013	M18X34,5	100	37982.180.034	M33X58,5	25	37982.330.058
M8X16,6	200	37982.080.016	M20X39	100	37982.200.039	M36X63	25	37982.360.630
M10X21	200	37982.100.021	M22X42	50	37982.220.042			
M12X25,4	100	37982.120.025	M24X48,5	50	37982.240.048			

- Warning: electro-galvanizing of these products may cause hydrogen embrittlement.

37986 NORD-LOCK Vibration proof washers large outside diameter

Y09A

Material: Steel
 Surface treatment: Deltaprotekt
 Packaging: Self service

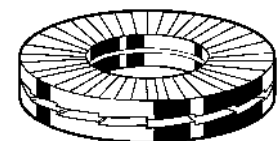

Z	☒	Art.number	Z	☒	Art.number	Z	☒	Art.number
M6X13,5(25PC)	1	37986.060.001	M10X21(25PC)	1	37986.100.001	M16X30,7(10PC)	1	37986.160.001
M8X16,6(25PC)	1	37986.080.001	M12X25,4(10PC)	1	37986.120.001	M20X39(10PC)	1	37986.200.001

- Warning: electro-galvanizing of these products may cause hydrogen embrittlement.

Vibration proof washer large outside diameter Stainless steel

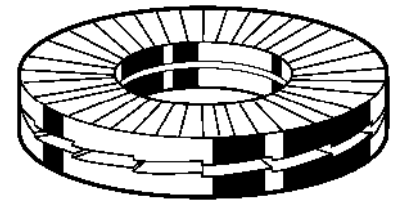
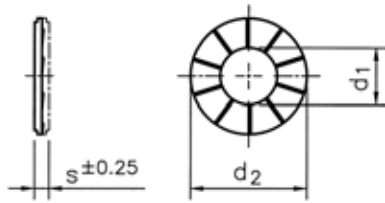

Technical data

For nom.size	d ₁	d ₂	s (Set)
M4	4,4	9	2,2
M5	5,4	10,8	2,2
M6	6,5	13,5	2,2
M8	8,7	16,6	2,2
M10	10,7	21	2,2
M12	13	25,4	3,2
M14	15,4	30,7	3,2
M16	17	30,7	3,2
M18	19,5	34,5	3,2
M20	21,4	39	3,2
M22	23,4	42	3,2
M24	25,3	48,5	3,2
M27	28,4	48,5	6,8
M30	31,4	58,5	6,8

- For general information concerning NORD-LOCK vibration proof fasteners, see INFO-page.
- Technical brochure available on request.

Article groups

Material	Packaging	Code	Page
St.St. A4	Standard	55453	7-86
St.St. A4	Self service	55456	7-86

7

55453 NORD-LOCK Vibration proof washer large outside diameter R47A

Material Stainless steel A4
Packaging Standard

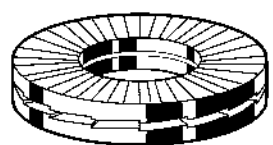
For nom. size x d2	☒	Art.number	For nom. size x d2	☒	Art.number	For nom. size x d2	☒	Art.number
M4X9	200	55453.040.009	M12X25,4	100	55453.120.025	M22X42	50	55453.220.042
M5X10,8	200	55453.050.010	M14X30,7	100	55453.140.030	M24X48,5	50	55453.240.048
M6X13,5	200	55453.060.013	M16X30,7	100	55453.160.030	M27X48,5	25	55453.270.048
M8X16,6	200	55453.080.016	M18X34,5	100	55453.180.034	M30X58,5	25	55453.300.058
M10X21,0	200	55453.100.021	M20X39	100	55453.200.039			

55456 NORD-LOCK Vibration proof washer large outside diameter Y09A

Material Stainless steel A4
Packaging Self service



For nom. size x d2	☒	Art.number	For nom. size x d2	☒	Art.number	For nom. size x d2	☒	Art.number
M6X13,5(10PC)	1	55456.060.001	M10X21(10PC)	1	55456.100.001	M16X30,7(5PC)	1	55456.160.001
M8X16,6(10PC)	1	55456.080.001	M12X25,4(5PC)	1	55456.120.001	M20X39(5PC)	1	55456.200.001