

# SMALL PARTS STORAGE SYSTEMS

A range of simple but effective small parts storage systems designed to cater for a wide range of materials and applications.

<b>Product</b>	<b>Lead Time</b> (Working Days)	<b>Page</b>
Topstore - TC Semi-Open Fronted Containers . . . . .	(5)	<b>4-5</b>
Topstore - NXT-GEN Semi-Open Fronted Stack & Nest Containers . . . . .	(5)	<b>6 - 7</b>
Topstore - Wall Mounted Louvred Panels . . . . .	(5)	<b>8 - 9</b>
Topstore - Wall Mounted Louvred Panel Kits & Fully Boxed Bin Kits . . . . .	(5)	<b>10 - 13</b>
Topstore - Louvred Panel Spacemasters . . . . .	(7)	<b>14 - 15</b>
Topstore - Louvred Panel Trolleys . . . . .	(7)	<b>16</b>
Topstore - Bench Stands & Louvred Panel Spigots . . . . .	(5)	<b>17</b>
Topstore - Mesh Baskets & Mesh Basket Louvred Panel Kits (5)		<b>18</b>
Topstore - Shelf Bins . . . . .	(5-15)	<b>19</b>
Topstore - Container Cabinets . . . . .	(7-10)	<b>20 - 21</b>
Topstore - Clearbox & Wall Units . . . . .	(5)	<b>22 - 23</b>
Visible Storage Cabinets, Turntables, Stands & Trolley Storage Bin Cabinets . . . . .	(5-15)	<b>24 - 27</b>
Topdrawer - Small Parts Cabinets and Trolley . . . . .	(5-7)	<b>28 - 30</b>
Parts Bins & Drawer Cabinets . . . . .	(5)	<b>31</b>
Topstore - Assortment Cases . . . . .	(5)	<b>32 - 33</b>
Compartment Boxes, Slide Racks & Base . . . . .	(5)	<b>34</b>
Topstore - Topbox & Storemaster Box . . . . .	(5)	<b>35</b>
Topstore - Space Bin Containers & Multi-functional Containers . . . . .	(5)	<b>36</b>
Topstore - Euro Containers Euro Container Tray Trolleys . . . . .	(5-7)	<b>37 - 39</b>
Topstore - Container Trolleys . . . . .	(5-7)	<b>40 - 42</b>

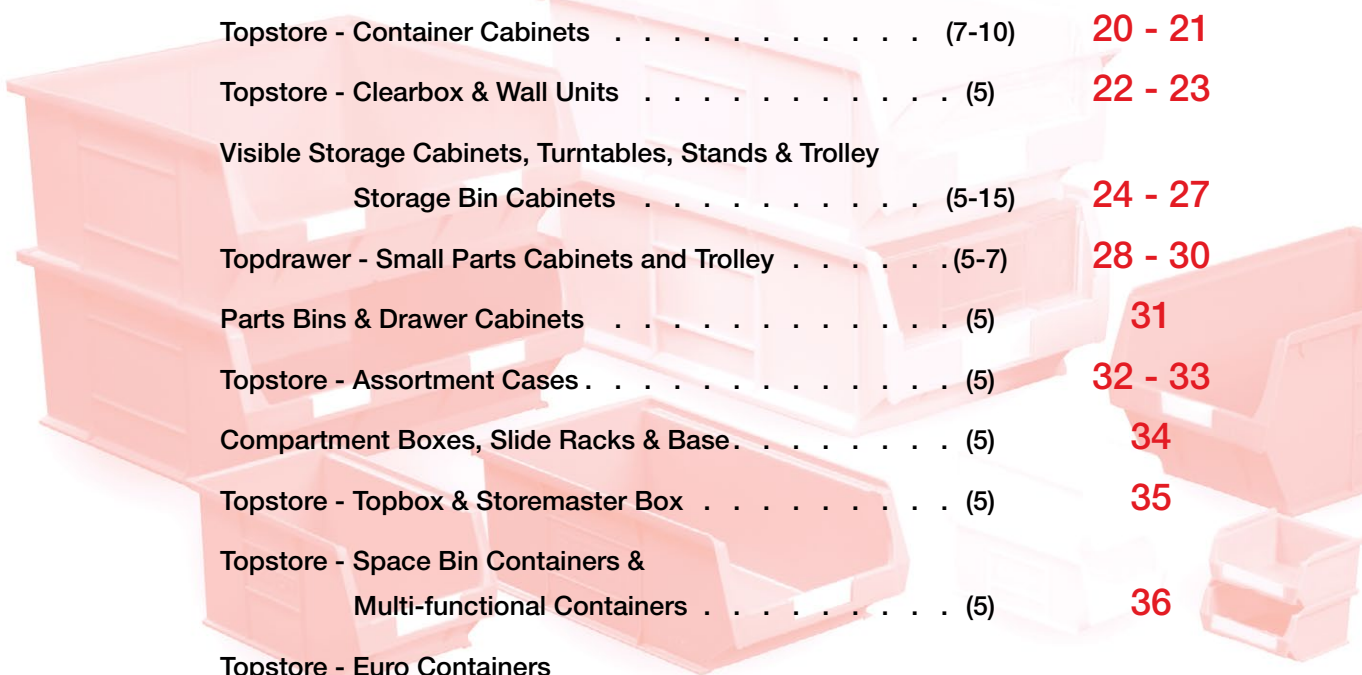

## Topstore - TC Semi-Open Fronted Containers

A simple and effective small parts storage system for a wide range of materials. Space saving, manufactured from polypropylene, can be stacked or for increased flexibility, used with Topstore Louvred Panels, Cabinets and Shelving.

Containers can be manufactured in own brand and colours for high volume users.

### Features:

- Strong, heavy duty with reinforced base, sides and stacking rim
- Durable, resistant to most industrial solvents.
- Material is capable of withstanding a temperature range from  $-15^{\circ}\text{C}$  to  $+50^{\circ}\text{C}$ , however this may not apply when under load or stress dependent on use or application.
- Hygienic, clean, smooth inside faces guard against build up of grease etc
- Index card slot for instant product identification (labels not supplied as standard please order separately)
- Available in 7 sizes and 6 colours as standard

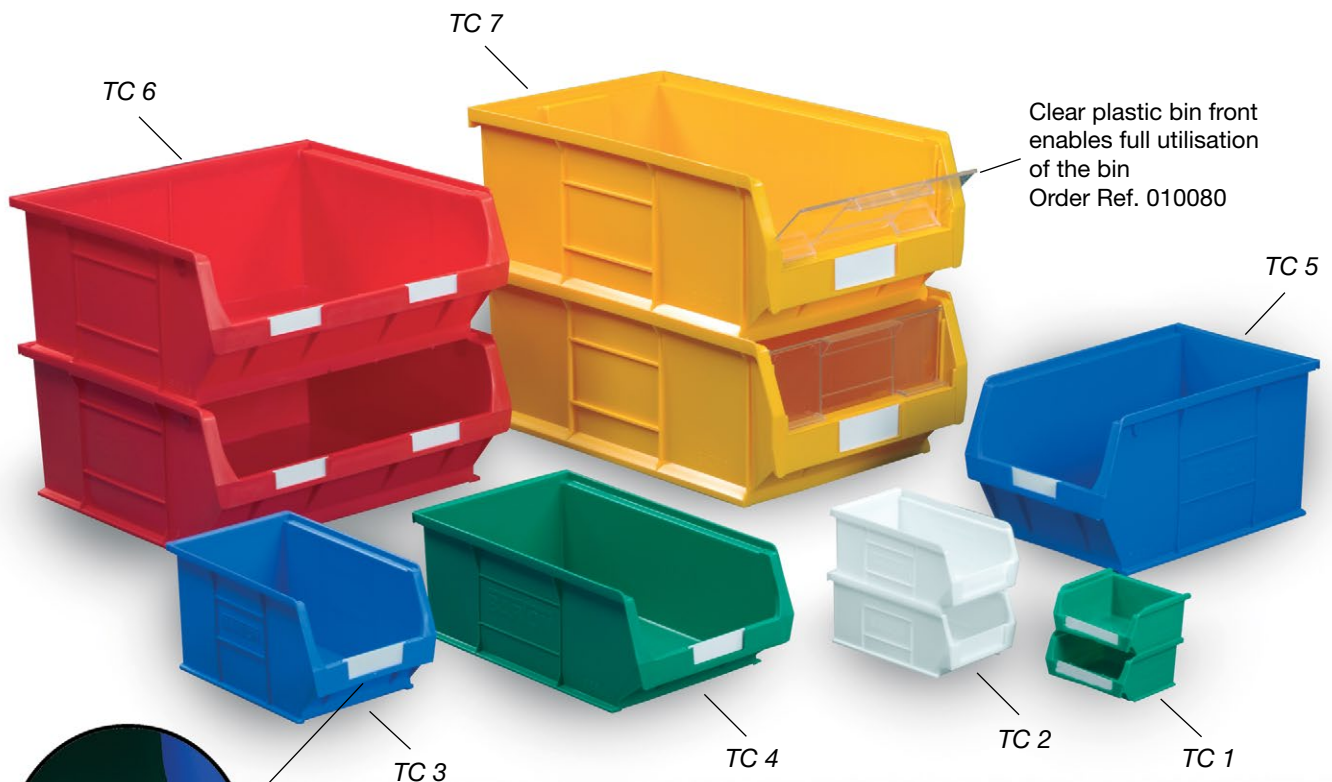

### Black Conductive Storage Containers

Are manufactured using antistatic, carbon, conductive particles/fibres which produce a low charging (antistatic) container which is less likely to damage static sensitive items.

This makes them ideal for use as part of a complete ESD control programme, as defined by BS IEC 61340-5-1:2007

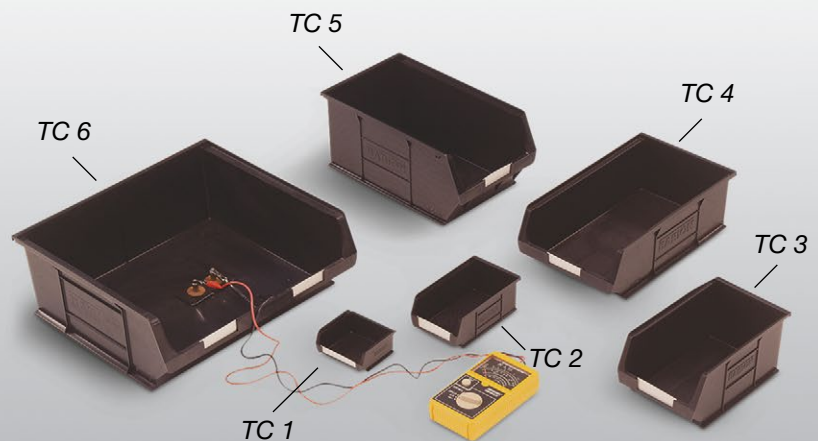

	TC1	TC2	TC3	TC4	TC5	TC6	TC7
No of containers per carton	20	20	10	10	10	5	5
Blue Order Ref	010011	010021	010031	010041	010051	010061	010071
Red Order Ref	010012	010022	010032	010042	010052	010062	010072
Green Order Ref	010014	010024	010034	010044	010054	010064	010074
Yellow Order Ref	010016	010026	010036	010046	010056	010066	010076
White Order Ref	010017	010027	010037	010047	010057	010067	010077
Price Per Carton	£20.78	£36.02	£38.21	£68.93	£96.46	£92.75	£110.56
Bin Fronts Order Ref	-	-	-	-	-	-	010080
Price of Each	-	-	-	-	-	-	£5.05
Black Conductive Order Ref	010019	010029	010039	010049	010059	010069	-
Price Per Carton	£48.68	£83.40	£111.45	£192.33	£294.87	£256.73	-
ID Labels Order Ref	010010	010020	010020	010020	010020	010020	010030
Price per pack of 100	£1.79	£1.89	£1.89	£1.89	£1.89	£1.89	£6.69
Plastic Label Holder Order Ref	-	010040	010040	010040	010040	010040	-
Price per pack of 100	-	£82.55	£82.55	£82.55	£82.55	£82.55	-
<b>BULK</b>	<b>TC1</b>	<b>TC2</b>	<b>TC3</b>	<b>TC4</b>	<b>TC5</b>	<b>TC6</b>	<b>TC7</b>
No of cartons per pallet	100	90	54	25	20	20	16
Blue Bulk Order Ref	010011/2000	010021/1800	010031/540	010041/250	010051/200	010061/100	010071/80
Red Bulk Order Ref	010012/2000	010022/1800	010032/540	010042/250	010052/200	010062/100	010072/80
Green Bulk Order Ref	010014/2000	010024/1800	010034/540	010044/250	010054/200	010064/100	010074/80
Yellow Bulk Order Ref	010016/2000	010026/1800	010036/540	010046/250	010056/200	010066/100	010076/80
White Bulk Order Ref	010017/2000	010027/1800	010037/540	010047/250	010057/200	010067/100	010077/80
Price	£1,673.95	£2,466.19	£1,685.86	£1,304.71	£1,500.44	£1,423.81	£1,351.94

### Technical Details

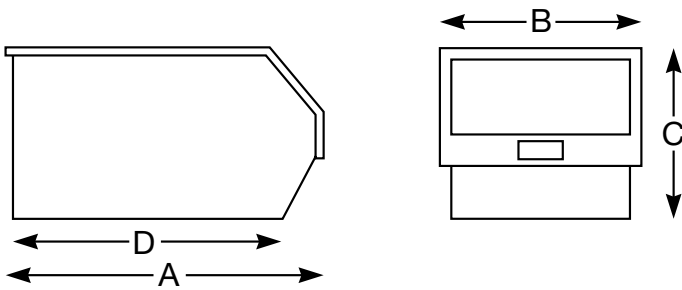

### Container Stacking Loads:

Please note that when stacking containers, the entire stack load is dispersed onto the base container therefore neither the individual load or the total load of the stacked containers (up to the max. stack height) should exceed the max. stack load.

Eg. The diagram below shows TC5 containers stacked to their max. of 4 high. As the max. stack load for TC5 is 45Kg, if containers 1, 2 & 3 are equally loaded they can each carry 15Kg. If they were stacked 3 high and equally loaded each container could carry 22.5Kg, or 2 high 45Kg.

For all bin capacities see the chart opposite

	TC1	TC2	TC3	TC4	TC5	TC6	TC7
Overall Length mm (A)	90	165	240	350	350	375	520
Overall Width mm (B)	100	100	150	205	205	420	310
Overall Height mm (C)	50	75	132	132	182	182	200
Overall Base Length mm (D)	64	143	200	300	300	310	450
Internal Length mm (A)	80	154	223	330	330	350	470
Internal Width mm (B)	88	88	128	179	177	378	270
Internal Height mm (C)	42	63	120	117	167	164	188
Internal Base Length mm (D)	65	131	188	287	287	295	435
Volume (Litres)	0.46	1.27	4.6	9.1	12.8	28.3	31.4
Maximum Container stack height	7	5	4	6	4	8	6
Maximum stack load capacity (kg) See details opposite	12	12	30	36	45	60	42
Max load capacity on louvred panel (kg) (based upon louvred panel in this publication)	8	8	20	24	30	40	28
Louvre Calculator	Please see page 9 for container / louvre panel configuration						



## Topstore - NXT-GEN Semi-Open Fronted Stack & Nest Containers

The next generation storage containers are designed to help you make the most of the space in your business.

Manufactured from polypropylene these containers combine the quality that you have come to expect with its revolutionary design enabling the bin to stack and nest, with the facility to be mounted onto louvred panels and to hold dividers to make the best possible use of the space available. NXT-GEN containers are also designed to be used with our cabinets and shelving systems to make this one of the most flexible bins available.

Available in 7 sizes and 3 colours as standard. Containers can be manufactured in own brand and colours for high volume users.

### Features:

- Dividers available to run front to back or left to right dependent on bin size
- When not in use, the bins will nest reducing the amount of storage space required
- Resistant to most chemicals, including oil and acids.
- Material is capable of withstanding a temperature range from -15°C to +50°C, however this may not apply when under load or stress dependent on use or application.
- Increased clear access facilities for easy selection
- Ergonomic design generates greater durability and strength
- Lifting handle on larger bins
- Index card slot for instant product identification (labels not supplied as standard please order separately)

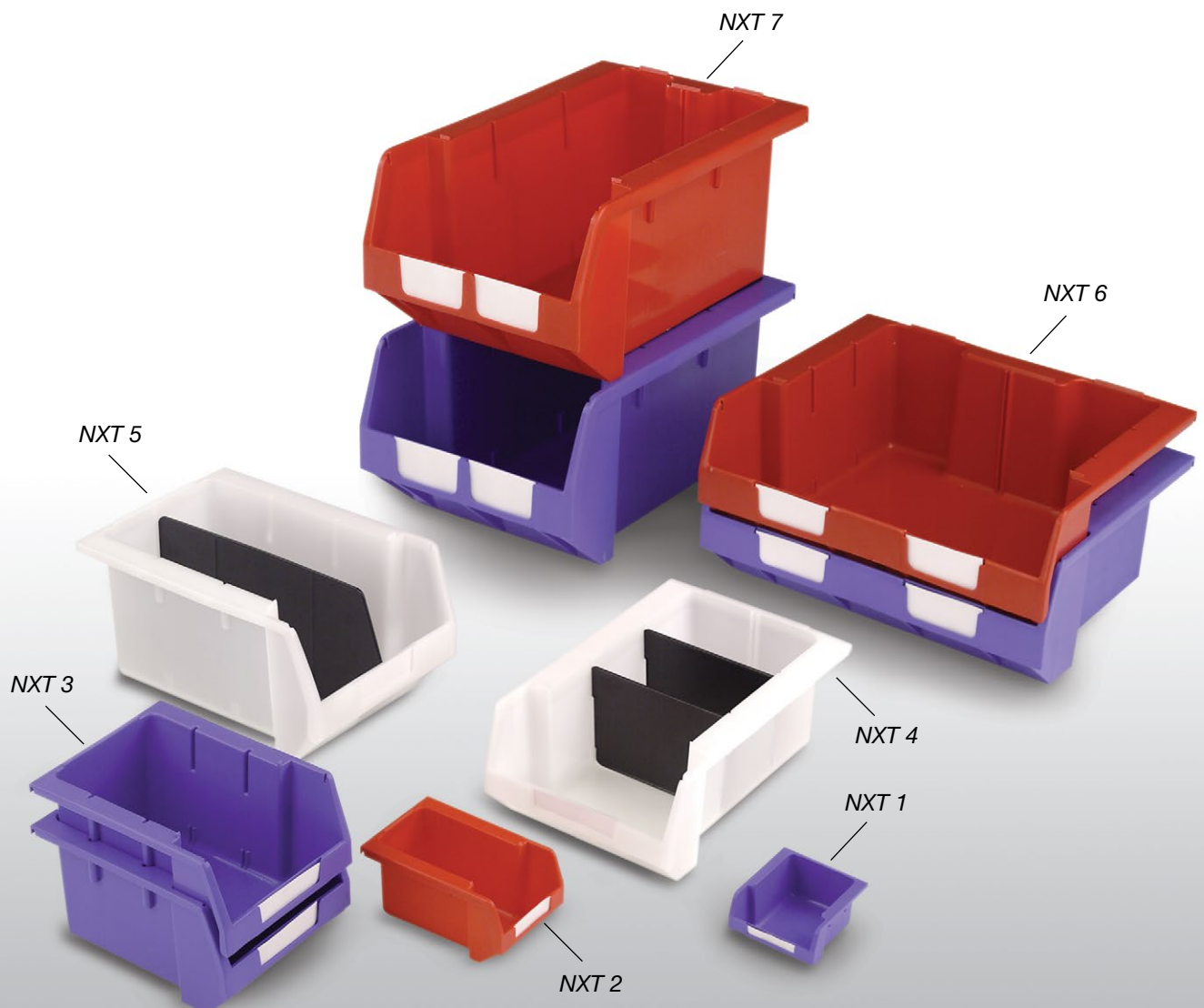



	NXT1	NXT2	NXT3	NXT4	NXT5	NXT6	NXT7
No of containers per carton	20	20	10	10	10	2	2
Blue Order Ref	010011SN	010021SN	010031SN	010041SN	010051SN	010061SN	010071SN
Red Order Ref	010012SN	010022SN	010032SN	010042SN	010052SN	010062SN	010072SN
White Order Ref	010017SN	010027SN	010037SN	010047SN	010057SN	010067SN	010077SN
Price Per Carton	£25.84	£44.52	£57.88	£86.07	£115.26	£39.77	£53.42
Dividers Front to Back - Order Ref	-	-	-	010048FB	010058FB	010068FB	010078FB
Pack Size	-	-	-	10	10	5	5
Price Per Pack	-	-	-	£33.39	£33.39	£20.41	£25.97
Dividers Left to Right - Order Ref	-	-	010038LR	010048LR	010058LR	-	010078LR
Pack Size	-	-	10	10	10	-	10
Price Per pack	-	-	£33.39	£33.39	£33.39	-	£33.39
ID labels Order Ref	010010SN	010020SN	010030SN	010040SN	010050SN	010060SN	010070SN
Price Per Pack of 100	£7.27	£4.60	£4.67	£10.02	£7.42	£7.42	£7.42

Technical Details

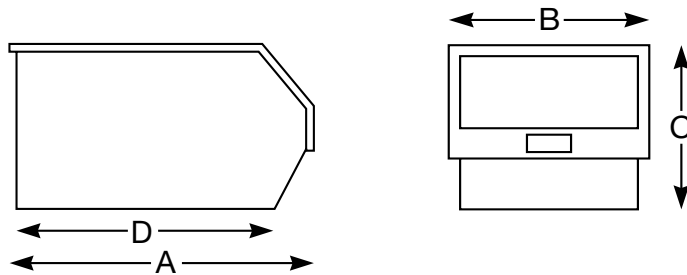

Container Stacking Loads:

Please note that when stacking containers, the entire stack load is dispersed onto the base container therefore neither the individual load or the total load of the stacked containers (up to the max. stack height) should exceed the max. stack load.

Eg. The diagram below shows NXT5 containers stacked to their max. of 4 high. As the max. stack load for TC5 is 60Kg, if containers 1, 2 & 3 are equally loaded they can each carry 20Kg. If they were stacked 3 high and equally loaded each container could carry 30Kg, or 2 high 60Kg.

For all bin capacities see the chart opposite

	NXT1	NXT2	NXT3	NXT4	NXT5	NXT6	NXT7
Overall Length mm (A)	103	172	250	355	355	385	510
Overall Width mm (B)	100	109	179	240	240	470	335
Overall Height mm (C)	50	80	130	130	180	180	246
Overall Base Length mm (D)	83	135	205	313	303	316	410
Internal Length mm (A)	95	160	234	332	332	326	449
Internal Width mm (B)	76	74	116	154	154	362	214
Internal Height mm (C)	47	77	128	128	174	173	244
Internal Base Length (D)	80	135	195	300	295	275	370
Volumes (Litres)	0.37	0.90	3.87	7.49	9.74	21.01	27.11
Maximum container stack height	7	5	4	4	4	5	4
Maximum stack load capacity (kg)	8	8	25	40	60	80	75
Max load cap on louvred panel (kg) (based upon louvred panel in this publication)	8	8	20	24	30	40	28
Louvre Calculator	Please see page 9 for container/louvre panel configuration						

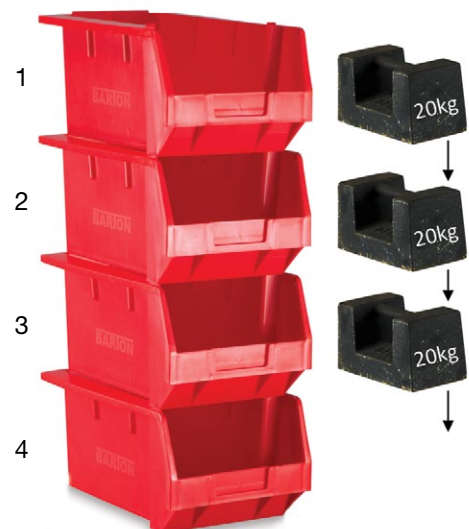

# Topstore - Wall Mounted Louvred Panels

Featuring the unique double indented louvre for extra strength, this system offers the ideal solution for wall mounting and many other applications for NXT-GEN and Topstore TC containers and accessories.

6 Imperial and 4 metric sizes available. Precision formed and finished epoxy powder coated in two colours. Other colours available.

TC Containers are suitable for both the metric blue and imperial grey louvred panels, however the NXT-GEN Containers are better suited to the metric blue louvred panels.



BLUE METRIC	500mm Wide				1000mm Wide				Height	
	TMP Ref	NL	Order Ref	Price (Each)	TMP Ref	NL	Order Ref	Price (Each)	Inches	mm
	5	60	010165NXT	£16.77	7	120	010167NXT	£27.45	19.75	500
	6	120	010166NXT	£27.45	8	240	010168NXT	£63.29	39.37	1000

GREY IMPERIAL	457mm (18") Wide				914mm (36") Wide				Height	
	TP Ref	NL	Order Ref	Price (Each)	TP Ref	NL	Order Ref	Price (Each)	Inches	mm
	1	48	010101	£13.85	5	96	010105	£25.93	17.25	438
	10	72	010110	£18.80	-	-	-	-	25.25	641
	2	108	010102	£25.97	6	216	010106	£55.28	37.25	946
	3	180	010103	£45.60	-	-	-	-	61.25	1556

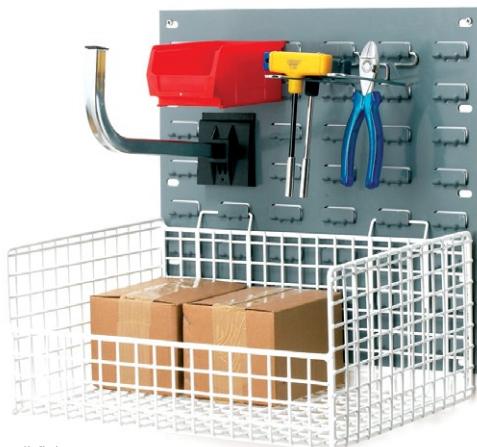

Excludes wall fixings

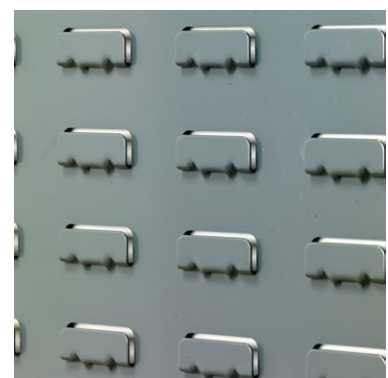

Unique double indent louvre for extra strength

### Louvre Value Configuration

1. To calculate approximately the amount of NXT-GEN or TC Containers or accessories that can be accommodated on a Topstore Louvred Panel, or part thereof, take the LV (Louvre Value) of the container or accessory and divide it in to the NL (Number of Louvres) per panel. To determine the number/size of Louvred Panels required to locate specific quantities of containers, simply reverse the above process.
2. To calculate the exact configuration, see diagram below.

IMPERIAL LOUVRED PANELS			
Panel Ref:	Total (NL) No. of Louvres	No. of Louvres in:	
		Width	Height
TP1	48	6	8
TP10	72	6	12
TP2	108	6	18
TP3	180	6	30
TP5	96	12	8
TP6	216	12	18

METRIC LOUVRED PANELS			
Panel Ref:	Total (NL) No. of Louvres	No. of Louvres in:	
		Width	Height
TMP5	60	6	10
TMP6	120	6	20
TMP7	120	12	10
TMP8	240	12	20

Container	No. of Louvres in:		
	Width	Height	Total (LV) Louvre Value
TC1	1.5	1	1.5
TC2	1.5	2	3
TC3	2	3	6
TC4	3	3	9
TC5	3	4	12
TC6	6	4	24
TC7	4	4	16

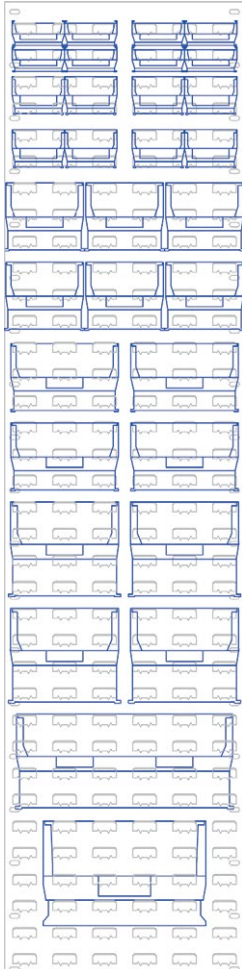

Container	No. of Louvres in:		
	Width	Height	Total (LV) Louvre Value
NXT1	1.5	1	1.5
NXT2	1.5	2	3
NXT3	3	3	9
Note: 5 NXT3 containers can fit in width on a 1000mm wide Louvred Panel			
NXT4	3	3	9
NXT5	3	4	12
NXT6	6	4	24
NXT7	4	5	20
Note: 3 NXT7 containers can fit in width on a 1000mm wide Louvred Panel			

2x TMP6 Louvred Panels shown below

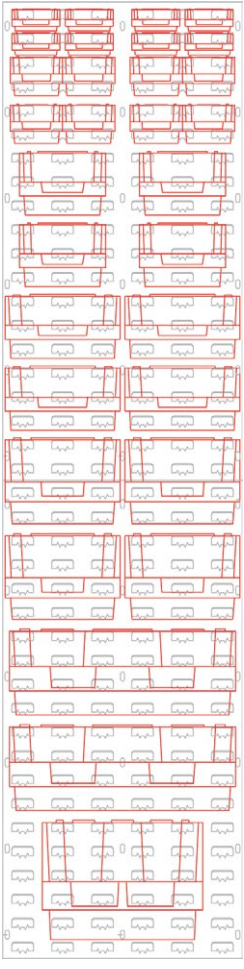

## Topstore - Wall Mounted Louvred Panel Kits

A range of modular pre-kitted TP10 louvred panels (H) 641 x (W) 457 mm in grey, complete with Topstore Containers ranging from TC2's to TC6's, in blue or red. For all other bin sizes and colours, see pages 4 and 5 and louvre panels see pages 8 and 9. (Other standard colours are available upon request).

These modular panel kits shown on pages 10-13 are designed to simplify the full utilisation of available wall space.

- All kits exclude wall fixings
- All containers come complete with I.D labels.

### Topstore - 1 Panel high x 2 Panels wide (H 641 x W 914mm) TC Bin Kits

Containers Included	Order Ref	Containers Included	Order Ref	No. of Louvred Panels per Kit	Price (Each)
48 x TC2 Blue Bins	010205B	48 x TC2 Red Bins	010205R	2	£78.50
24 x TC3 Blue Bins	010206B	24 x TC3 Red Bins	010206R	2	£81.16
16 x TC4 Blue Bins	010207B	16 x TC4 Red Bins	010207R	2	£90.54
12 x TC5 Blue Bins	010208B	12 x TC5 Red Bins	010208R	2	£94.89
6 x TC6 Blue Bins	010209B	6 x TC6 Red Bins	010209R	2	£91.83



010205R - TC2 Red



010207B - TC4 Blue

### Topstore - 1 Panel high x 3 Panels wide (H 641 x W 1371mm) TC Bin Kits

Containers Included	Order Ref	Containers Included	Order Ref	No. of Louvred Panels per Kit	Price (Each)
72 x TC2 Blue Bins	010210B	72 x TC2 Red Bins	010210R	3	£117.76
36 x TC3 Blue Bins	010211B	36 x TC3 Red Bins	010211R	3	£121.74
24 x TC4 Blue Bins	010212B	24 x TC4 Red Bins	010212R	3	£135.81
18 x TC5 Blue Bins	010213B	18 x TC5 Red Bins	010213R	3	£142.34
9 x TC6 Blue Bins	010214B	9 x TC6 Red Bins	010214R	3	£137.74



010211R - TC3 Red



010214B - TC6 Blue



Topstore - 1 Panel high x 4 Panels wide (H 641 x W 1828mm) TC Bin Kits

Containers Included	Order Ref	Containers Included	Order Ref	No. of Louvred Panels per Kit	Price (Each)
96 x TC2 Blue Bins	010215B	96 x TC2 Red Bins	010215R	4	£157.01
48 x TC3 Blue Bins	010216B	48 x TC3 Red Bins	010216R	4	£162.31
32 x TC4 Blue Bins	010217B	32 x TC4 Red Bins	010217R	4	£181.08
24 x TC5 Blue Bins	010218B	24 x TC5 Red Bins	010218R	4	£189.78
12 x TC6 Blue Bins	010219B	12 x TC6 Red Bins	010219R	4	£183.65



010216R - TC3 Red



010218B - TC5 Blue

Topstore - 2 Panels high x 1 Panel wide (H 1282 x W 457mm) TC Bin Kits

Containers Included	Order Ref	Containers Included	Order Ref	No. of Louvred Panels per Kit	Price (Each)
48 x TC2 Blue Bins	010205B	48 x TC2 Red Bins	010205R	2	£78.50
24 x TC3 Blue Bins	010206B	24 x TC3 Red Bins	010206R	2	£81.16
16 x TC4 Blue Bins	010207B	16 x TC4 Red Bins	010207R	2	£90.54
12 x TC5 Blue Bins	010208B	12 x TC5 Red Bins	010208R	2	£94.89
6 x TC6 Blue Bins	010209B	6 x TC6 Red Bins	010209R	2	£91.83



010206R - TC3 Red



010208B - TC5 Blue



010209R - TC6 Red

## Topstore - 2 Panels high x 2 Panels wide (H 1282 x W 914mm) TC Bin Kits \_\_\_\_\_

Containers Included	Order Ref	Containers Included	Order Ref	No. of Louvred Panels per Kit	Price (Each)
96 x TC2 Blue Bins	010215B	96 x TC2 Red Bins	010215R	4	£157.01
48 x TC3 Blue Bins	010216B	48 x TC3 Red Bins	010216R	4	£162.31
32 x TC4 Blue Bins	010217B	32 x TC4 Red Bins	010217R	4	£181.08
24 x TC5 Blue Bins	010218B	24 x TC5 Red Bins	010218R	4	£189.78
12 x TC6 Blue Bins	010219B	12 x TC6 Red Bins	010219R	4	£183.65

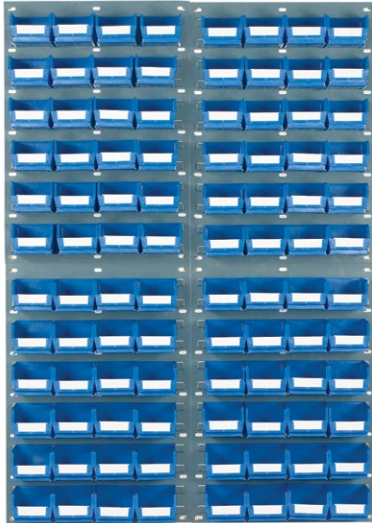

010215B - TC2 Blue



010218R - TC5 Red

## Topstore - 2 Panels high x 3 Panels wide (H 1282 x W 1371mm) TC Bin Kits \_\_\_\_\_

Containers Included	Order Ref	Containers Included	Order Ref	No. of Louvred Panels per Kit	Price (Each)
144 x TC2 Blue Bins	010220B	144 x TC2 Red Bins	010220R	6	£235.51
72 x TC3 Blue Bins	010221B	72 x TC3 Red Bins	010221R	6	£243.47
48 x TC4 Blue Bins	010222B	48 x TC4 Red Bins	010222R	6	£271.63
36 x TC5 Blue Bins	010223B	36 x TC5 Red Bins	010223R	6	£284.67
18 x TC6 Blue Bins	010224B	18 x TC6 Red Bins	010224R	6	£275.48



010223R - TC5 Red



010224B - TC6 Blue

## Topstore - 2 Panels high x 4 Panels wide (H 1282 x W 1828mm) TC Bin Kits

Containers Included	Order Ref	Containers Included	Order Ref	No. of Louvred Panels per Kit	Price (Each)
192 x TC2 Blue Bins	010225B	192 x TC2 Red Bins	010225R	8	£314.01
96 x TC3 Blue Bins	010226B	96 x TC3 Red Bins	010226R	8	£324.63
64 x TC4 Blue Bins	010227B	64 x TC4 Red Bins	010227R	8	£362.17
48 x TC5 Blue Bins	010228B	48 x TC5 Red Bins	010228R	8	£379.57
24 x TC6 Blue Bins	010229B	24 x TC6 Red Bins	010229R	8	£367.30



010226B - TC3 Blue

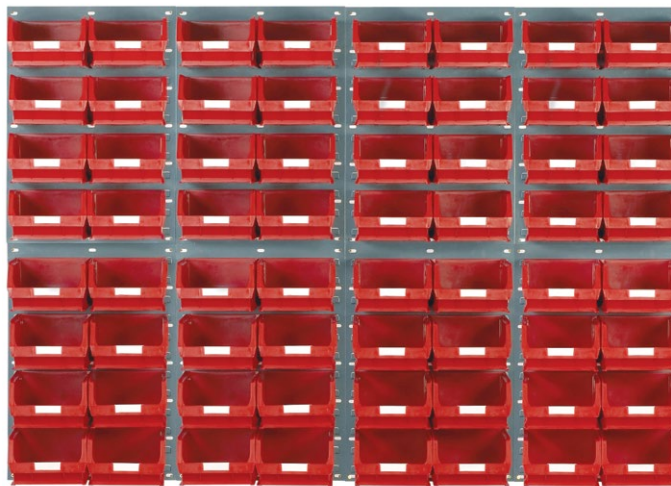

010227R - TC4 Red

## Topstore - Fully Boxed Bin Kits

Pre-kitted Topstore Containers and Louvred Panels. Virtually any combination can be made to order.

Boxed Kit Contents	Order Ref	Pack Quantity	Price (Per Pack)
1 x 300 (H) x 320mm (W) Red Wall Mounted L/Panel c/w 6 x TC1 & 6 x TC2 Blue Bins	010094RL/10	10	£163.71
1 x 300 (H) x 320mm (W) Blue Wall Mounted L/Panel c/w 6 x TC1 & 6 x TC2 Red Bins	010094BL/10	10	£163.71
1 x 300 (H) x 457mm (W) Red Wall Mounted L/Panel c/w 6 x TC3 Blue Bins	010095RL/5	5	£111.01
1 x 300 (H) x 457mm (W) Blue Wall Mounted L/Panel c/w 6 x TC3 Red Bins	010095BL/5	5	£111.01
Grey TP1 Panel c/w 8 x TC2 Red Bins & 8 x TC2 Blue Bins	010171/5	5	£145.45
Grey TP1 Panel c/w 16 x TC2 Red Bins	010171/R/5	5	£145.45
Grey TP2 Panel c/w 9 x TC3 Red & 9 x TC3 Blue Bins	010172/5	5	£318.01
Grey TP10 Panel c/w 24 x TC2 Red Bins	010174/5	5	£171.31

Excludes wall fixings



010094BL



010171



010095RL

## Topstore - Louvred Panel Spacemasters

Single or double sided freestanding storage units available in 3 heights for increased storage capacity when using both NXT-GEN and TC Topstore containers and accessories.

Units are finished epoxy powder coated blue with silver/grey feet.

For larger applications order one "starter" and the appropriate number of "addas" to make this a complete solution to suit individual requirements.

Heavy duty adjusters permit levelling on uneven surfaces.

Other colours available.

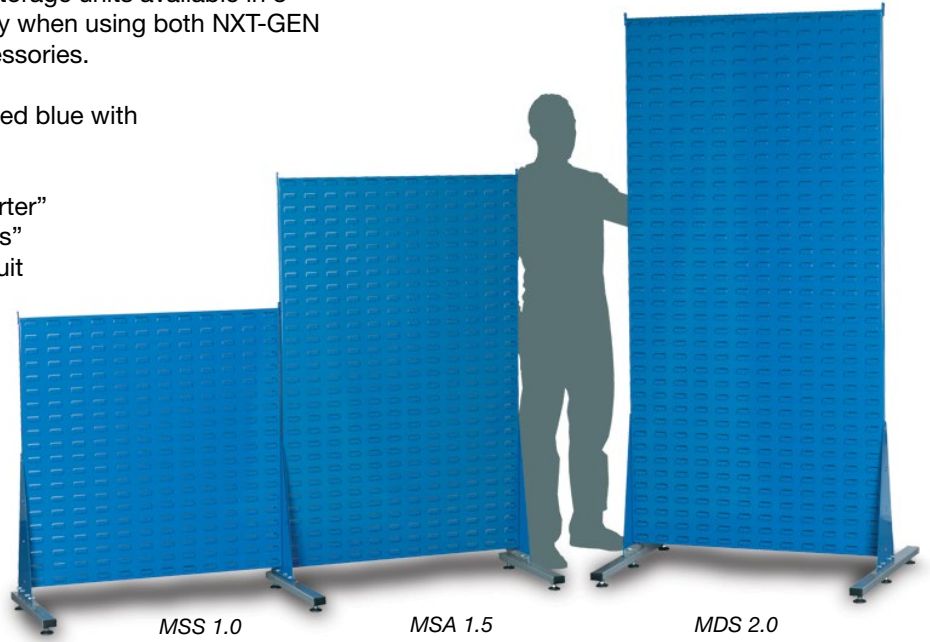

## Topstore - Spacemaster Stands Only

Racks (Excluding Containers) - Single Sided								
Starter Ref	Order Ref	Price (Each)	Adda Ref	Order Ref	Price (Each)	NL	H x W x D (mm)	Capacity
MSS 1.0	010810NXT	£174.15	MSA 1.0	010820NXT	£145.91	240	1100 x 1000 x 500	400 kgs
MSS 1.5	010830NXT	£208.80	MSA 1.5	010840NXT	£179.04	360	1600 x 1000 x 500	400 kgs
MSS 2.0	010850NXT	£249.31	MSA 2.0	010860NXT	£219.56	480	2100 x 1000 x 500	400 kgs

Racks (Excluding Containers) - Double Sided								
Starter Ref	Order Ref	Price (Each)	Adda Ref	Order Ref	Price (Each)	NL	H x W x D (mm)	Capacity
MDS 1.0	010910NXT	£250.83	MDA 1.0	010920NXT	£211.02	480	1100 x 1000 x 750	800 kgs
MDS 1.5	010930NXT	£300.73	MDA 1.5	010940NXT	£260.92	720	1600 x 1000 x 750	800 kgs
MDS 2.0	010950NXT	£371.37	MDA 2.0	010960NXT	£330.49	960	2100 x 1000 x 750	800 kgs

(Note: NL= number of louvres, please refer to page 9)



011522B

011520A (Starter)

011521A (Adda)

011514B

## Topstore - Louvred Panel Spacemasters TC Bin Kits

- All containers come complete with I.D labels

### MSS1.5 Spacemaster Single Sided Starter Kits

Containers Included	Order Ref	Containers Included	Order Ref	Containers Included	Order Ref	Price (Each)
64 x TC2 Red & 56 x TC2 Blue	011514A	120 x TC2 Red	011514B	120 x TC2 Blue	011514C	£331.20
30 X TC3 Red & 30 x TC3 Blue	011516A	60 x TC3 Red	011516B	60 x TC3 Blue	011516C	£333.68
20 x TC4 Red & 20 x TC4 Blue	011518A	40 x TC4 Red	011518B	40 x TC4 Blue	011518C	£347.97
16 x TC5 Red & 12 x TC5 Blue	011520A	28 x TC5 Red	011520B	28 x TC5 Blue	011520C	£368.85
8 x TC6 Red & 6 x TC6 Blue	011522A	14 x TC6 Red	011522B	14 x TC6 Blue	011522C	£341.69

Dimensions for above models: (H) 1600 x (W) 1000 x (D) 500mm

### MSA1.5 Spacemaster Single Sided Adda Kits

Containers Included	Order Ref	Containers Included	Order Ref	Containers Included	Order Ref	Price (Each)
64 x TC2 Red & 56 x TC2 Blue	011515A	120 x TC2 Red	011515B	120 x TC2 Blue	011515C	£315.80
30 X TC3 Red & 30 x TC3 Blue	011517A	60 x TC3 Red	011517B	60 x TC3 Blue	011517C	£303.92
20 x TC4 Red & 20 x TC4 Blue	011519A	40 x TC4 Red	011519B	40 x TC4 Blue	011519C	£318.21
16 x TC5 Red & 12 x TC5 Blue	011521A	28 x TC5 Red	011521B	28 x TC5 Blue	011521C	£339.09
8 x TC6 Red & 6 x TC6 Blue	011523A	14 x TC6 Red	011523B	14 x TC6 Blue	011523C	£311.93

Dimensions for above models: (H) 1600 x (W) 1000 x (D) 500mm

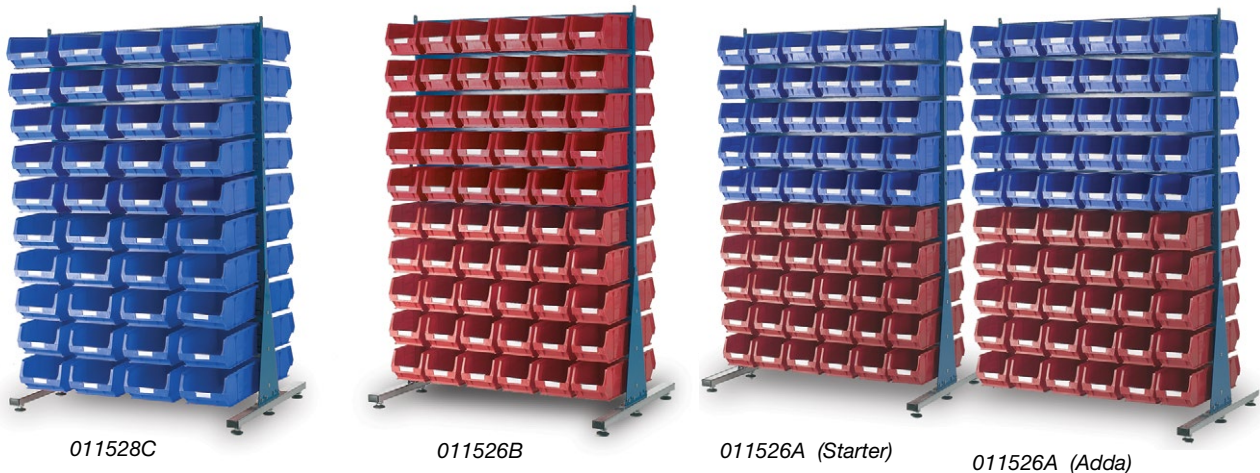

### MDS1.5 Spacemaster Double Sided Starter Kits

Containers Included	Order Ref	Containers Included	Order Ref	Containers Included	Order Ref	Price (Each)
128 x TC2 Red & 112 x TC2 Blue	011524A	240 x TC2 Red	011524B	240 x TC2 Blue	011524C	£568.40
60 x TC3 Red & 60 x TC3 Blue	011526A	120 x TC3 Red	011526B	120 x TC3 Blue	011526C	£548.52
40 x TC4 Red & 40 x TC4 Blue	011528A	80 x TC4 Red	011528B	80 x TC4 Blue	011528C	£577.11
32 x TC5 Red & 24 x TC5 Blue	011530A	56 x TC5 Red	011530B	56 x TC5 Blue	011530C	£618.86
16 x TC6 Red & 12 x TC6 Blue	011532A	28 x TC6 Red	011532B	28 x TC6 Blue	011532C	£564.54

Dimensions for above models: (H) 1600 x (W) 1000 x (D) 750mm

### MDA1.5 Spacemaster Double Sided Adda Kits

Containers Included	Order Ref	Containers Included	Order Ref	Containers Included	Order Ref	Price (Each)
128 x TC2 Red & 112 x TC2 Blue	011525A	240 x TC2 Red	011525B	240 x TC2 Blue	011525C	£544.80
60 x TC3 Red & 60 x TC3 Blue	011527A	120 x TC3 Red	011527B	120 x TC3 Blue	011527C	£507.64
40 x TC4 Red & 40 x TC4 Blue	011529A	80 x TC4 Red	011529B	80 x TC4 Blue	011529C	£536.22
32 x TC5 Red & 24 x TC5 Blue	011531A	56 x TC5 Red	011531B	56 x TC5 Blue	011531C	£577.97
16 x TC6 Red & 12 x TC6 Blue	011533A	28 x TC6 Red	011533B	28 x TC6 Blue	011533C	£523.66

Dimensions for above models: (H) 1600 x (W) 1000 x (D) 750mm

## Topstore - Louvred Panel Trolleys

When you require a solution for component picking in aisles or requiring movement, we offer a range of trolleys compatible with both NXT-GEN and Topstore TC Containers and Accessories.

Units are finished epoxy powder coated blue with silver/grey base.

The trolleys are supplied as standard with 100mm diameter wheels/casters (2 fixed/2 swivel) non-marking rubber tyred and enable a safe load to be manoeuvred with ease. Other colours available.

- All containers come complete with I.D labels

### Topstore - Trolley Stands Only

Trolley Stands Only (Excluding Containers)						
	Ref	NL	Capacity (Kg)	H x W x D (mm)	Order Ref	Price (Each)
Single	MTS4	240	125	1160 x 1000 x 530	010425NXT	£247.01
Sided	MTS5	360	125	1660 x 1000 x 530	010430NXT	£271.05
Double	MTD4	480	250	1160 x 1000 x 750	010455NXT	£309.90
Sided	MTD5	720	250	1660 x 1000 x 750	010460NXT	£352.67

(Note: NL= number of louvres, please refer to page 9)



### Topstore - Single Sided Louvred Panel Trolley TC Bin Kits

Containers Included	Order Ref	Containers Included	Order Ref	Containers Included	Order Ref	Price (Each)
40 x TC2 Red & 40 x TC2 Blue	011504A	80 x TC2 Red	011504B	80 x TC2 Blue	011504C	£320.08
18 x TC3 Red & 18 x TC3 Blue	011506A	36 x TC3 Red	011506B	36 x TC3 Blue	011506C	£321.94
12 x TC4 Red & 12 x TC4 Blue	011508A	24 x TC4 Red	011508B	24 x TC4 Blue	011508C	£330.51
8 x TC5 Red & 12 x TC5 Blue	011510A	20 x TC5 Red	011510B	20 x TC5 Blue	011510C	£327.04
6 x TC6 Blue & 4 x TC6 Red	011512A	10 x TC6 Red	011512B	10 x TC6 Blue	011512C	£341.93

Dimensions for above models: (MTS4) (H) 1160 x (W) 1000 x (D) 530mm

### Topstore - Double Sided Louvred Panel Trolley TC Bin Kits

Containers Included	Order Ref	Containers Included	Order Ref	Containers Included	Order Ref	Price (Each)
80 x TC2 Red & 80 x TC2 Blue	011505A	160 x TC2 Red	011505B	160 x TC2 Blue	011505C	£456.04
36 x TC3 Red & 36 x TC3 Blue	011507A	72 x TC3 Red	011507B	72 x TC3 Blue	011507C	£459.75
24 x TC4 Red & 24 x TC4 Blue	011509A	48 x TC4 Red	011509B	48 x TC4 Blue	011509C	£476.90
16 x TC5 Red & 24 x TC5 Blue	011511A	40 x TC5 Red	011511B	40 x TC5 Blue	011511C	£469.94
12 x TC6 Blue & 8 x TC6 Red	011513A	20 x TC6 Red	011513B	20 x TC6 Blue	011513C	£499.74

Dimensions for above models: (MTD4) (H) 1160 x (W) 1000 x (D) 750mm



011513A



011510A



011505A

## Topstore - Bench Stands

Epoxy powder coated blue panel and silver/grey side supports, these bench stands are suitable for use with the smaller range of NXT-GEN and TC containers and are available in 500(H) x 500mm(W) and 500(H) x 1000mm(W).

- All containers come complete with I.D labels



010186NXT



010187NXT

Model	1	2	3	4	5	6	7	8
H x W (mm)	500 x 500	500 x 1000	500 x 500	500 x 500	500 x 500	500 x 1000	500 x 500	500 x 1000
No. of Louvres	60	120	60	60	60	120	60	120
Containers Included	None	None	20 Blue NXT2	20 Red NXT2	20 Red TC2	9 Red NXT1 27 Red NXT2 5 Red NXT3	20 Blue TC2	20 Red TC2 12 Blue TC3
Order Ref	010184NXT	010185NXT	010186NXT	010186NXT/R	010186TC	010187NXT	010187TC	010188TC
Price (Each)	£43.59	£54.57	£66.11	£66.11	£62.12	£104.54	£62.12	£97.45

## Topstore - Louvred Panel Spigots

Designed to fit onto Topstore Louvred Panels our range of Topstore Spigots are ideal for storing items such as coils that will not store easily on a shelf.

Available in 19mm square and 13mm round tube with a durable ABS plastic back plate for heavier applications.

Wire spigots are available in single and double options, manufactured from 3.6mm wire, the single spigots come complete with a rubber end cap for safety.

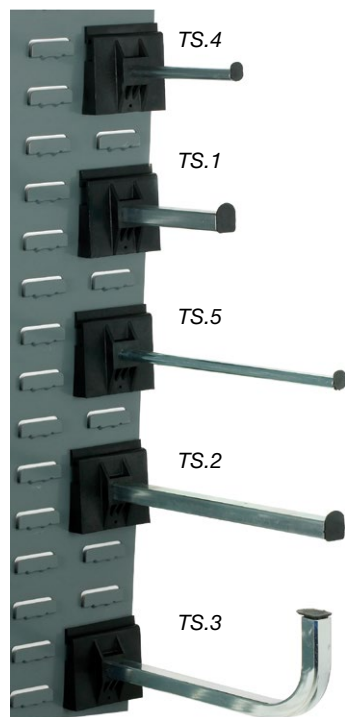

Description	Order Ref	Price
<b>Louvre Value = 2 Load Capacity = 10kgs</b>		
TS.1 19mm Sq Tube x 152mm Long	011031	£49.25
TS.2 19mm Sq Tube x 304mm Long	011032	£66.30
TS.3 19mm Sq Tube x 304mm Long x 108mm upstand	011033	£89.78
TS.4 13mm Diameter Round Tube x 152mm Long	011034	£48.51
TS.5 13mm Diameter Round Tube x 304mm Long	011035	£58.24
<b>Louvre Value = 1 Load Capacity = 1kg</b>		
TSW.6 Single Wire x 152mm Long	011036	£15.44
TSW.7 Single Wire x 203mm Long	011037	£16.45
TSW.8 Double Wire x 152mm Long	011038	£17.34
TSW.9 Double Wire x 203mm Long	011039	£21.30

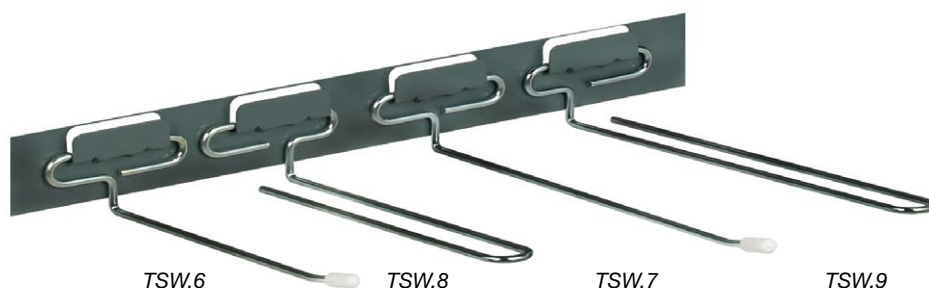

## Topstore - Mesh Baskets

Topstore Mesh Baskets fit onto both metric and imperial panels. They are available in two depths with an option to fit adjustable front to back dividers. Both baskets and dividers are white plastic coated.

Small Basket				
Order Ref	H x W x D (mm)	Louvre Value	Capacity (Kg)	Price (Each)
012593	200 x 460 x 200	30	30	£44.52
012597	Front/Back Divider	N/A	N/A	£14.47

Large Basket				
Order Ref	H x W x D (mm)	Louvre Value	Capacity (Kg)	Price (Each)
012594	200 x 460 x 330	30	30	£51.94
012598	Front/Back Divider	N/A	N/A	£16.47

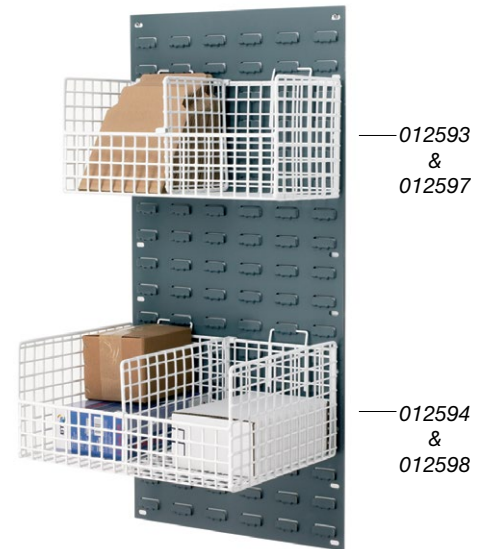

## Topstore - Mesh Basket Louvred Panel Kits

Some additional modular pre-kitted TP2 Louvred Panels (H) 946 x (W) 457mm in grey, complete with either small or large mesh baskets.

Baskets Included	H x W (mm)	Order Ref	No. of Louvred Panels per Kit	Price (Each)
3 x Small Mesh Baskets	946 x 457	010230SB	1	£158.05
6 x Small Mesh Baskets	946 x 914	010231SB	2	£316.09
9 x Small Mesh Baskets	946 x 1371	010232SB	3	£474.14
12 x Small Mesh Baskets	946 x 1828	010233SB	4	£632.18
3 x Large Mesh Baskets	946 x 457	010234LB	1	£180.31
6 x Large Mesh Baskets	946 x 914	010235LB	2	£360.61
9 x Large Mesh Baskets	946 x 1371	010236LB	3	£540.92
12 x Large Mesh Baskets	946 x 1828	010237LB	4	£721.22

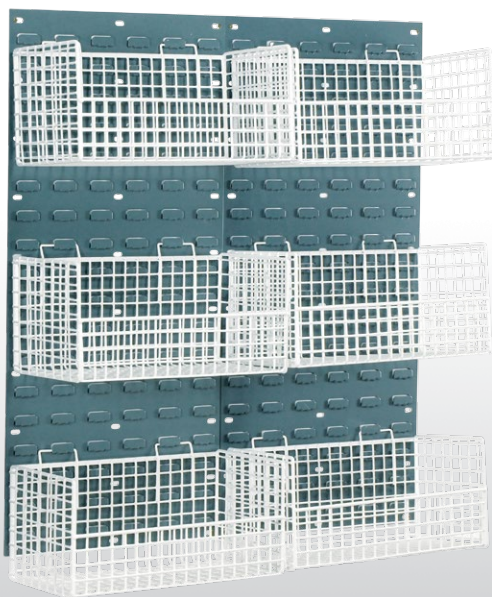

010231SB

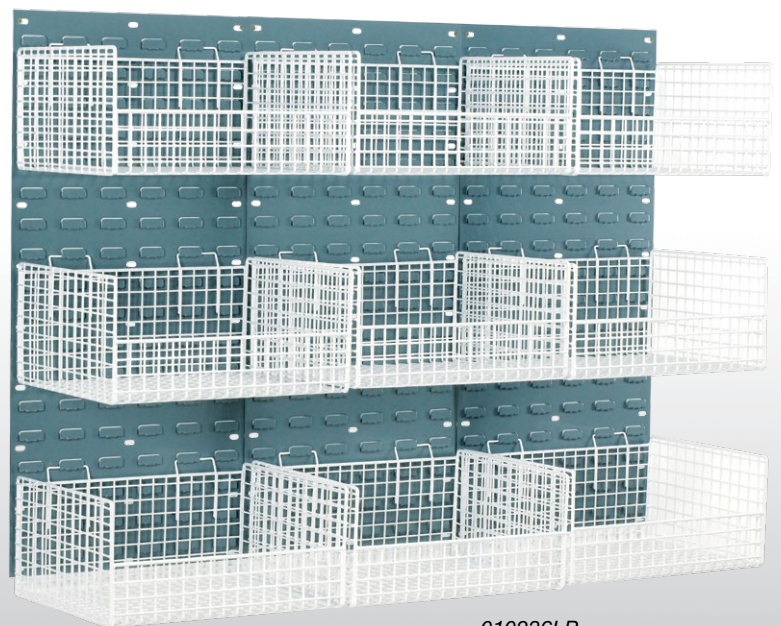

010236LB



## Topstore - Shelf Bins

Available in 17 sizes, these tough, blue polypropylene bins offer a practical alternative solution to cardboard or steel (other colours are available - please contact our sales department for details).

Shelf bins are impervious to most oils, greases and chemicals and make the best use of available shelf space, particularly when used with shelving systems.

The bin design includes a semi-open front, a facility for transparent dividers and a bin stop. For identification, durable plastic label holders (complete with labels) are available.

When not in use the bins will nest, reducing the amount of storage space required.



Bin Stop

Type	L x W x H (mm)	Max Dividers per Bin	Pack Size	Order Ref	Price (Per Pack)
3009 Bin	300 x 90 x 95	5	40	066501	£137.31
3012 Bin	300 x 120 x 95	3	30	066502	£114.60
3018 Bin	300 x 180 x 95	3	20	066503	£100.00
3024 Bin	300 x 240 x 95	3	15	066504	£81.02
4009 Bin	400 x 90 x 95	7	40	066505	£174.98
4012 Bin	400 x 120 x 95	4	30	066506	£153.84
4018 Bin	400 x 180 x 95	4	20	066507	£118.48
4024 Bin	400 x 240 x 95	3	15	066508	£105.44
4024-15 Bin	400 x 240 x 150	3	10	066509	£86.97
5009 Bin	500 x 90 x 95	9	40	066510	£211.94
5012 Bin	500 x 120 x 95	6	30	066511	£181.02
5018 Bin	500 x 180 x 95	6	20	066512	£138.81
5024 Bin	500 x 240 x 95	3	15	066514	£130.97
5024-15 Bin	500 x 240 x 150	3	10	066515	£121.64
6012 Bin	600 x 120 x 95	7	30	066516	£219.83
6024 Bin	600 x 240 x 95	7	15	066517	£142.75
6024-15 Bin	600 x 240 x 150	4	10	066518	£142.68
Bin Stop	80 x 40	N/A	100	066520	£65.68
P09 Divider	90 x 95	N/A	50	066525	£23.45
P12 Divider	120 x 95	N/A	50	066526	£25.76
P18 Divider	180 x 95	N/A	25	066527	£22.57
P24 Divider	240 x 95	N/A	25	066529	£33.76
P24-15 Divider	240 x 150	N/A	10	066530	£14.71
Label Holder inc. label	75 x 30	N/A	100	066536	£25.97

Bins are not supplied with dividers/labels or bin stops, please order separately.

## Topstore - Container Cabinets

Topstore Container Cabinets come fully assembled and their robust all-steel construction offers flexible and secure storage for the office, workshop or stockroom.

Available in 3 sizes, epoxy powder coated silver/grey carcass and blue doors. Shelves are galvanised and adjustable at 50mm centres. All cabinets suit TC Containers, NXT-GEN Containers and Shelf Bins.

A fully recessed handle comes complete with 2 keys.

All shelves have a maximum load of 25kgs (Uniformly Distributed Load).

All containers come complete with I.D labels



**Model 1:** (H) 1580 x (W) 770 x (D) 330mm

Description	Order Ref	Shelves	Price (Each)
Cabinet	013000	0	£307.97
Cabinet c/w shelves	013005	6	£386.43
Pack of 3 shelves - 770 (W) x 330mm (D)	013004	3	£39.36
Cabinet c/w 40 x NXT3 Blue Containers	013008NXT	9	£497.09
Cabinet c/w 40 x NXT3 Red Containers	013009NXT	9	£497.09
Cabinet c/w 40 x NXT3 White Containers	013010NXT	9	£497.09
Cabinet c/w 40 x TC3 Blue Containers	013008	9	£472.72
Cabinet c/w 40 x TC3 Red Containers	013009	9	£472.72
Cabinet c/w 40 x TC3 White Containers	013010	9	£472.72
Cabinet c/w 40 x TC3 Blue Containers	013011	4	£407.33
Cabinet c/w 40 x TC3 Red Containers	013012	4	£407.33
Cabinet c/w 40 x TC3 White Containers	013013	4	£407.33

# Topstore - Container Cabinets

Model 2: (H) 1000 x (W) 1015 x (D) 430mm

Description	Order Ref	Shelves	Price (Each)
Cabinet	013020	0	£293.83
Cabinet c/w shelves	013024	3	£348.26
Pack of 3 shelves - 1015 (W) x 430mm (D)	013023	3	£50.38
Cabinet c/w 24 x NXT4 Red Containers	013025NXT	5	£445.78
Cabinet c/w 24 x NXT4 Blue Containers	013026NXT	5	£445.78
Cabinet c/w 24 x NXT4 White Containers	013027NXT	5	£445.78
Cabinet c/w 24 x TC4 Red Containers	013025	5	£431.28
Cabinet c/w 24 x TC4 Blue Containers	013026	5	£431.28
Cabinet c/w 24 x TC4 White Containers	013027	5	£431.28
Cabinet c/w 24 x TC4 Red Containers	013028	2	£376.86
Cabinet c/w 24 x TC4 Blue Containers	013029	2	£376.86
Cabinet c/w 16 x TC5 Blue Containers	013031	2	£377.61
Cabinet c/w 16 x TC5 Red Containers	013032	2	£377.61
Cabinet c/w 16 x TC5 Blue Containers	013034	3	£395.75
Cabinet c/w 16 x TC5 Red Containers	013035	3	£395.75
Cabinet c/w 8 x TC6 Red Containers	013037	3	£389.60
Cabinet c/w 8 x TC6 Blue Containers	013038	3	£389.60
Cabinet c/w 8 x TC6 Red Containers	013040	2	£371.76
Cabinet c/w 8 x TC6 Blue Containers	013041	2	£371.76
Cabinet c/w 4 x TC6 Red & 8 x TC5 Blue Containers	013043	2	£374.22



013055NXT



013008NXT



013027NXT

Model 3: (H) 2000 x (W) 1015 x (D) 430mm

Description	Order Ref	Shelves	Price (Each)
Cabinet	013050	0	£385.32
Cabinet c/w shelves	013051	6	£494.17
Pack of 3 shelves - 1015 (W) x 430mm (D)	013023	3	£50.38
Cabinet c/w 52 x NXT4 Red Containers	013055NXT	11	£730.10
Cabinet c/w 52 x NXT4 Blue Containers	013056NXT	11	£730.10
Cabinet c/w 52 x NXT4 White Containers	013057NXT	11	£730.10
Cabinet c/w 4 x TC6 Red, 28 x TC5 Blue & 4 x TC4 Red Containers	013052	8	£652.70
Cabinet c/w 20 x TC5 Blue & 24 x TC4 Red Containers	013053	10	£682.07
Cabinet c/w 52 x TC4 Red Containers	013055	11	£697.95
Cabinet c/w 52 x TC4 Blue Containers	013056	11	£697.95
Cabinet c/w 52 x TC4 White Containers	013057	11	£697.95
Cabinet c/w 52 x TC4 Red Containers	013058	6	£608.77
Cabinet c/w 52 x TC4 Blue Containers	013059	6	£608.77
Cabinet c/w 52 x TC4 White Containers	013060	6	£608.77

## Topstore - Clearbox

The ideal dust-free storage and display system for the warehouse, workshop, retail and trade. Each unit contains a number of removable transparent inner compartments suitable for a wide range of items with a beige outer body.

To provide the ultimate in flexibility of application, Clearbox can be fixed directly to the wall, fitted to freestanding metal racks (single or double sided) or which can be converted to provide a mobile unit.

Whatever the format, Clearbox provides the answer.

- Flexible – suitable for a variety of uses and applications
- Non-toxic – suitable for use with food stuffs
- Strong – outer body manufactured from high-impact polystyrene plastic and inner compartments from ABS plastic
- Order picking – tilting transparent compartments allow easy retrieval of items with maximum display potential
- A retaining bar is available (for all Clearbox sizes) to secure individual compartments in place and prevent accidental displacement when in transit. Finished zinc plated.

*All units have a common width of 600mm and are available in 6 sizes, each providing a different number of compartments suitable for a range of small components.*

Clearbox Units			
Ref	H x W x D (mm)	Order Ref	Price (Each)
No. 9	77 x 600 x 64	051380	£11.49
No. 6	113 x 600 x 93	051381	£15.52
No. 5	164 x 600 x 135	051382	£23.26
No. 4	207 x 600 x 171	051383	£31.80
No. 3	240 x 600 x 197	051384	£41.46
No. 2	353 x 600 x 310	051385	£90.90
Retaining bar		051090	£1.90

Clearbox Units (BULK)			
Ref	Pack Quantity	Order Ref	Price (Per Pack)
No. 9	10	051380/10	£98.50
No. 6	10	051381/10	£133.07
No. 5	10	051382/10	£199.41
No. 4	10	051383/10	£272.58
No. 3	5	051384/5	£177.70
No. 2	5	051385/5	£389.57



No. 2



No. 5



No. 6



No. 3



No. 9



No. 4

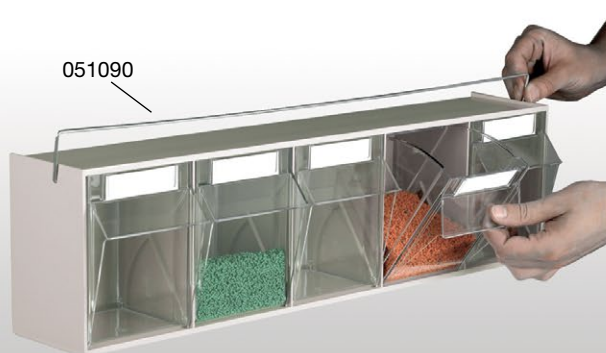

051090

*All units come complete with I.D labels / Excludes wall fixings*

**NOTE:**

**A:** To calculate the quantity of Clearbox units that can be accommodated on any one of the applications, divide the height of the unit into the storage space of the application.

**B:** To enable Clearbox units to be fitted onto other applications marked \*, please order 2 Fixing Brackets (Ref 051169) per unit.

Description	Dimensions H x W x D (mm)	Clearbox Storage Space	Order Ref	Price (Each)
*Single sided floor stand	1880 x 600 x 440	1850mm	051130	£208.35
*Double sided floor stand	1880 x 600 x 610	1850mm	051140	£208.35
*Double sided Trolley	1350 x 600 x 600	1190mm	051100	£271.57
Fixing Bracket	2 required per unit	-	051169	N/A

Clearbox Combinations - Complete with Clearbox Units									
Description	H x W x D (mm)	No. 9	No. 6	No. 5	No. 4	No. 3	No. 2	Order Ref	Price (Kit)
Single Sided Floor Stand	1880 x 600 x 440	4	3	1	1	2	1	051130K	£562.73
Single Sided Floor Stand	1880 x 600 x 440	-	-	-	9	-	-	051131	£543.97
Double Sided Floor Stand	1880 x 600 x 610	8	6	2	2	4	2	051140K	£917.10
Double Sided Floor Stand	1880 x 600 x 610	-	-	-	18	-	-	051141	£879.60
Double Sided Trolley	1420 x 600 x 610	-	4	2	2	2	2	051100K	£741.47
Double Sided Trolley	1420 x 600 x 610	-	-	-	-	10	-	051142	£713.65

Labels Supplied



051131



051141



051142

**Topstore - Wall Mounted Clearbox Frame**

- Ideal for wall storage in a garage, studio or a workshop.
- Can accommodate a combination of Clearbox Units, from No.3 - No.9.
- Quick and easy to assemble.
- Complete with fixings for 5 Clearbox Units.



Description	H x W x D (mm)	Order Ref	Price (Each)
Wall Mounted Clearbox Frame	600 x 600 x 15	051260	£43.00
Wall Mounted Clearbox Kit c/w 1 x No.5 3 x No.6 1 x No.9	600 x 600 x 108	051261	£125.00

## Visible Storage Cabinets

Our Visible Storage Cabinets combine a stylish industrial design with practical accessories to provide flexible and efficient small parts storage. Available in two cabinet sizes, 290 and 550mm high, which can be wall mounted, self-standing or mounted on space saving turntables, stands and trolley's

- Durable dark grey polypropylene frame and galvanised steel shelves.
- Crystal clear polystyrene drawers with corrugated base offering easy product identification and picking.
- Self adhesive labels are provided for each drawer
- Accessories : Left to right & front to back dividers.

### 290 Series (H) 290 x (W) 310 x (D) 180mm



Ref	Drawer Type (See Below)	No. Of Drawers In Cabinet	Price (Each)	Left to Right Dividers	Max Qty Per Drawer	Price (Pk of 10)	Front to Back Dividers	Max Qty Per Drawer	Price (Pk of 10)
290-3	L-00	30 pcs	£29.20	V-00	5 pcs	£1.75	-	-	-
291-3	L-01	24 pcs	£29.20	V-01	5 pcs	£1.85	V-012	1 pc	£3.25
292-3	L-02	12 pcs	£29.20	V-02	5 pcs	£2.85	V-012	3 pcs	£3.25
294-3	L-04	12 pcs	£29.20	V-04	5 pcs	£2.45	V-0456	1 pc	£3.30
296-3	L-06	4 pcs	£29.20	V-06	5 pcs	£4.70	V-0456	5 pcs	£3.30
297-3	L-07	6 pcs	£29.20	V-07	5 pcs	£3.85	V-078	3 pcs	£4.10
290C3	L-01	12 pcs	£29.20	V-01	5 pcs	£1.85	V-012	1 pc	£3.25
	L-04	3 pcs		V-04	5 pcs	£2.45	V-0456	1 pc	£3.30
	L-06	1 pc		V-06	5 pcs	£4.70	V-0456	5 pcs	£3.30

### 550 Series (H) 550 x (W) 310 x (D) 180mm

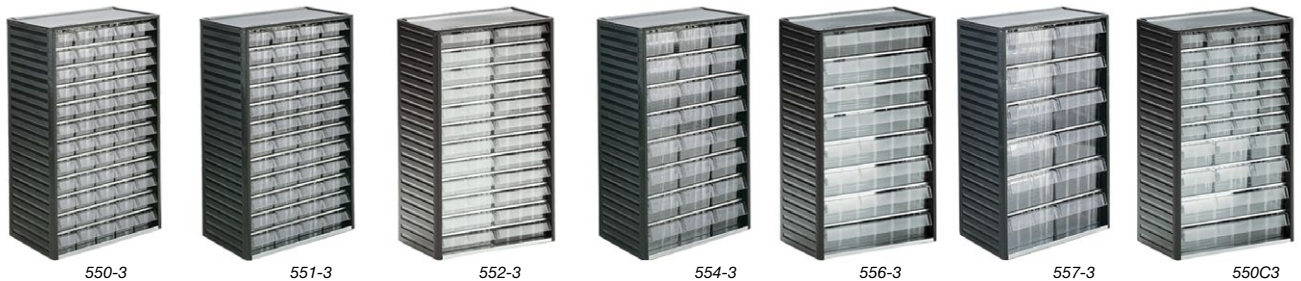

Ref	Drawer Type (See Below)	No. Of Drawers In Cabinet	Price (Each)	Left to Right Dividers	Max Qty Per Drawer	Price (Pk of 10)	Front to Back Dividers	Max Qty Per Drawer	Price (Pk of 10)
550-3	L-00	60 pcs	£52.20	V-00	5 pcs	£1.75	-	-	-
551-3	L-01	48 pcs	£52.20	V01	5 pcs	£1.85	V-012	1 pc	£3.25
552-3	L-02	24 pcs	£52.20	V-02	5 pcs	£2.85	V-012	3 pcs	£3.25
554-3	L-04	24 pcs	£52.20	V-04	5 pcs	£2.45	V-0456	1 pc	£3.30
556-3	L-06	8 pcs	£52.20	V-06	5 pcs	£4.70	V-0456	5 pcs	£3.30
557-3	L-07	12 pcs	£52.20	V-07	5 pcs	£3.85	V-078	3 pcs	£4.10
550C3	L-01	24 pcs	£52.20	V-01	5 pcs	£1.85	V-012	1 pc	£3.25
	L-04	6 pcs		V-04	5 pcs	£2.45	V-0456	1 pc	£3.30
	L-06	2 pc		V-06	5 pcs	£4.70	V-0456	5 pcs	£3.30

Order Ref	Outer Dimensions D x W x H (mm)	Inner Dimensions D x W x H (mm)	Pk Qty	Price (Per Pack)
L-00	175 x 55 x 37	146 x 47 x 32	120	£86.40
L-01	175 x 69 x 37	146 x 61 x 32	96	£72.00
L-02	175 x 138 x 37	146 x 128 x 32	48	£74.40
L-04	175 x 92 x 59	146 x 82 x 55	45	£58.50
L-06	175 x 277 x 59	146 x 266 x 55	15	£49.50
L-07	175 x 138 x 81	146 x 128 x 74	24	£52.80

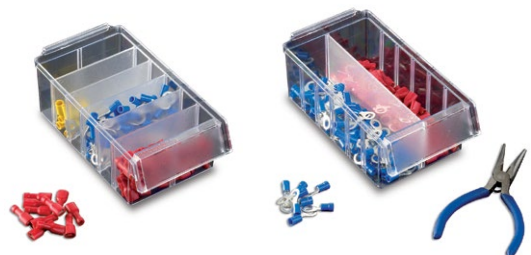

# Visible Storage Turntables, Stands & Trolley

Perfect storage and identification of thousands of small components, offering storage for up to 4,320 different items on a floor area of only 0.25 square metres.

## Spacemiser Turntable

This unit includes a ball bearing base and dividing trays. The assembly holds 3 layers of 4 visible storage cabinets (12 in total) from the 550 series. A pre-configured kit is available (as shown), or the cabinets can be ordered separately from the 550 series as shown on the page opposite.

Complete assembly (D x W x H) 500 x 500 x 1730mm

Product Description	Cabinets (ordered separately)	Capacity (Kg)	Order Ref	Price (Each)
Spacemiser	550 - 550C3 (for 12 cabinets)	400	12-550	£181.00
Spacemiser complete kit	With cabinets 4 No. 551-3 4 No. 554-3 4 No. 557-3		12-550 Kit	£807.40



## Bench Top Spacemiser Turntable

This unit includes a ball bearing base, and can hold 2 visible storage cabinets from the 290 or 550 series which are ordered separately.

Complete assembly

(D x W x H) 360 x 310 x 300mm (series 290)

(D x W x H) 360 x 310 x 560mm (series 550)

Product Description	Capacity (Kg)	Order Ref	Price (Each)
Bench Top Spacemiser Turntable	50	PTP-5	£66.00



Single Stand



Double Stand



Cabinet Trolley

This assembly holds 4 visible storage cabinets from the 550 series, which are ordered separately. Free standing frame epoxy powder coated in grey. Overall dimensions  
D x W x H: 420 x 760 x 1585mm.

This holds 8 visible storage cabinets from the 550 series, which are ordered separately. Free standing frame epoxy powder coated in grey. Overall dimensions  
D x W x H: 600 x 760 x 1585mm.

This assembly holds 8 visible storage cabinets from the 550 series, which are ordered separately. Construction as double stand with 12mm laminated board, which creates a bottom shelf. 4 all swivel castors Ø 100mm. (Two with brakes). Trolley frame epoxy powder coated in grey. Overall dimensions  
D x W x H: 600 x 760 x 1700mm.

Product Description	Capacity (Kg)	Cabinets (ordered separately)	Order Ref	Price (Each)
Single Stand	50	Max cabinets per unit (4)	BS-550L	£222.00
Double Stand	100	Max cabinets per unit (8)	BS-550T	£234.00
Trolley	150	Max cabinets per unit (8)	BT-550	£278.00

## Storage Bin Cabinets

Our range of storage bin cabinets can be stacked, wall mounted or fitted to assemblies and turntable units. Durable epoxy grey enamelled steel cabinets complete with plastic shelf bins in a range of sizes complete with backstops and label holders. The crystal clear bins are manufactured from polystyrene (PS) and coloured bins from polypropylene (PP). Dividers are ordered separately, please see the page opposite.



Cabinet Overall Dimensions D x W x H (mm)	Drawer Type	Drawer Qty	Overall Drawer Dimensions D x W x H (mm)	Order Code Clear Drawer (PS)	Order Code Grey Drawer (PP)	Order Code Red Drawer (PP)	Order Code Blue Drawer (PP)	Price (Each)
Series 300								
300 x 400 x 395	3010	16	300 x 92 x 82	1630-1	1630-3	1630-5	1630-6	£95.00
300 x 400 x 395	3020	8	300 x 186 x 82	0830-1	0830-3	0830-5	0830-6	£87.00
Series 400								
400 x 400 x 395	4010	16	400 x 92 x 82	1640-1	1640-3	1640-5	1640-6	£110.00
400 x 400 x 395	4020	8	400 x 186 x 82	0840-1	0840-3	0840-5	0840-6	£96.00
400 x 400 x 395	4040	4	400 x 186 x 180	0440-1	n/a	0440-5	0440-6	£94.00

## Turntable Units

Compact storage systems for use in maintenance, production and storage areas. Space saving practical turntable assemblies are ideal for the storage and easy identification of thousands of components. Such assemblies offer storage for up to 1,792 different items on a floor space of only 0.64 square metres. When wall space is limited the turntable assembly, strategically placed, is a huge space saver. Easy assembly without tools.

### Model 16-300

This unit holds 16 bin cabinets of 300mm depth, ordered separately.

### Model 16-400

This unit holds 16 bin cabinets of 400mm depth ordered separately.



Product Description	Cabinets (ordered separately)	Turntable Dimensions D x W x H (mm)	Load Capacity (Kg)	Pack Qty	Order Ref	Price (Each)
Turntable assembly	0830/1630	700 x 700 x 1680	800	1	16-300	£380.00
Turntable assembly	0840/1640/0440	800 x 800 x 1680		1	16-400	£414.00
Turntable kit	c/w 8x 0830/8x 1630	700 x 700 x 1680		1	16-300 KIT	£1,726.00
Turntable kit	c/w 8x 0840/8x 1640	800 x 800 x 1680		1	16-400 KIT	£1,939.00



## Storage Bin Cabinets

High density storage cabinets for use in workshop, stores and many other environments. The Storage Bin Cabinets have a robust construction, with the option to make them mobile by adding castors. This compact storage system offers storage for up to 336 different items on a floor area of only 0.25 square meters.

Each cabinet includes a grey epoxy enamelled steel frame, complete with shelf bins with backstops, labels and a polypropylene cover. Adjustable feet are provided for fine levelling. Dividers and castor sets are available separately.



Order Ref	Bin Colour	Bin Material	Drawer Type	Drawer Qty	Frame DxWxH(mm)	Load Capacity	Pack Qty	Price (Each)
2440-3	Grey	Polypropylene PP	4020	24 pcs	410x605x870	240Kg (Total)	1	£352.00
2440-5	Red	Polypropylene PP						
2440-6	Blue	Polypropylene PP						
4840-3	Grey	Polypropylene PP	4010	48 pcs	410x605x870	30Kg (Per Shelf)	1	£386.00
4840-5	Red	Polypropylene PP						
4840-6	Blue	Polypropylene PP						

### Castor set PS-LH

A castor set is available to make this high density cabinet mobile. 4 castors Ø100mm, 2 with brakes. Load capacity of cabinet with castor is 150kg.

Dimensions of cabinet with castors:  
D x W x H: 410 x 605 x 980mm



Order Ref	Suitable for	Pack Qty	Price (Each)
PS-LH	Castor set = 4 castors 100mm, 2 with brakes 1 set = 4pcs	1 set	£79.00

### Dividers

Product	Order Ref	Suitable for Drawer Type	Max Divider Locations Per Drawer	Pack Qty	Price (Each)
Dividers	D-10	3010	4	10	£3.80
		4010	6	10	£3.80
	D-20	3020	4	10	£6.60
		4020	6	10	£6.60
	V-40	4040	3	10	£15.50



## Topdrawer

A selection of free-standing units and trolley ideal for most environments. The range provides medium to high volume storage for small parts and is ideal for both office and factory use. The cabinets can also be bench or worktop mounted, or if required can be wall fitted (wall fixings are not included). A 48 drawer cabinet complete with doors is also available for secure storage.

A unique slide design ensures the drawers run smoothly. With an anti-drop structure the drawers are safely secured when in use. All cabinets are manufactured from pre-galvanised steel and powder coated in grey.



052005

052003

The drawers are manufactured from high impact ABS/Styrene and include inner dividers and I.D labels. They are fitted with clear front windows for easier visibility of stored items. Drawers are also oil corrosion resistant and have high impact strength. All of the drawers can be completely removed.

Additional dividers and index labels can be ordered separately.



Topdrawer - Cabinets c/w 12,24 & 48 Drawers

Description	H x W x D (mm)	Cabinet Capacity (Kg)	Drawer Size H x W x D (mm)	Drawer Capacity (Kg)	Max Divider Locations Per Drawer	No. of Dividers Provided	Order Ref	Price (Each)
12 Drawer Cabinet	350 x 586 x 290	72	69 x 163 x 289	6	5	12	052002	£140.00
24 Drawer Cabinet	640 x 586 x 290	144	69 x 163 x 289	6	5	24	052003	£225.00
Dividers (Pack of 100)	-	-	-	-	-	-	052009/100	£43.00
48 Drawer cabinet without doors	937 x 586 x 222	240	69 x 120 x 218	5	3	48	052004	£290.00
48 Drawer cabinet with doors (3 point locking mechanism)	970 x 586 x 270	240	69 x 120 x 218	5	3	48	052005	£450.00
Dividers (Pack of 200)	-	-	-	-	-	-	052010/200	£43.00
Index Labels (Pack of 100)	76 x 14	-	-	-	-	-	052020/100	£4.50



052003



052002



052004

Three Point locking mechanism



052005

## Topdrawer - Cabinets c/w 60/75 Drawers

A range of cabinets complete with 60 or 75 transparent styrene drawers which are designed for easier product selection while utilising full use of natural light.

Description	H x W x D (mm)	Cabinet Capacity (Kg)	Drawer Sizes H x W x D (mm)	Drawer Capacity (Kg)	No. of Dividers Provided	Max Divider Locations Per Drawer	Order Ref	Price (Each)
60 Drawer Cabinet	937 x 586 x 222	228	55 x 120 x 218	3.8	60	3	052007	£305.00
75 Drawer Cabinet	937 x 586 x 222	247.5	55 x 90 x 218	3.3	75	3	052006	£345.00
Dividers for 60 Drawer Cabinet (Pack of 200)		-	-	-	-	-	052012/200	£43.00
Dividers for 75 Drawer Cabinet (Pack of 250)		-	-	-	-	-	052011/250	£39.00
Index Labels (Pack of 100)	76 x 14	-	-	-	-	-	052020/100	£4.50



052006



052007

## Topdrawer - Trolley c/w 30 Drawers

This trolley with its fixed chrome handle and swivel castors provides easy transportation of stored goods. The galvanised shelves prevent damage from acid, oxidation and abrasion and can hold up to 50 kg per level.

The trolley drawers are designed with an anti-drop device when drawer has been fully pulled out.

- Rubber castors Ø100mm, 2 braked and 2 swivel



052001

Description	H x W x D (mm)	Trolley Capacity (Kg)	Drawer Size H x W x D (mm)	Drawer Capacity (Kg)	No. of Dividers Provided	Max Divider Locations Per Drawer	Order Ref	Price (Each)
30 Drawer Trolley	880 x 880 x 400	300	105 x 164 x 375	10	60	7	052001	£560.00
Dividers (Pack of 60)		-	-	-	-	-	052008/60	£37.00
Index Labels (Pack of 100)	126 x 21	-	-	-	-	-	052021/100	£11.00

## Parts Bins

Our Parts Bins are ideal for storing small parts in warehouses or workshops. Strong and robust they are available in four options of 24, 40, 42 and 72 compartments.

- All welded, cold rolled steel
- Fully hemmed 28mm high bin fronts to hold labels and retain parts
- Roll-formed sides for increased strength and stability
- Ribbed and hemmed dividers provide added strength
- Modular with most 304mm deep bins and drawer cabinets, mounting holes are located in both the top and bottom
- Durable grey powder coat finish
- Supplied fully assembled

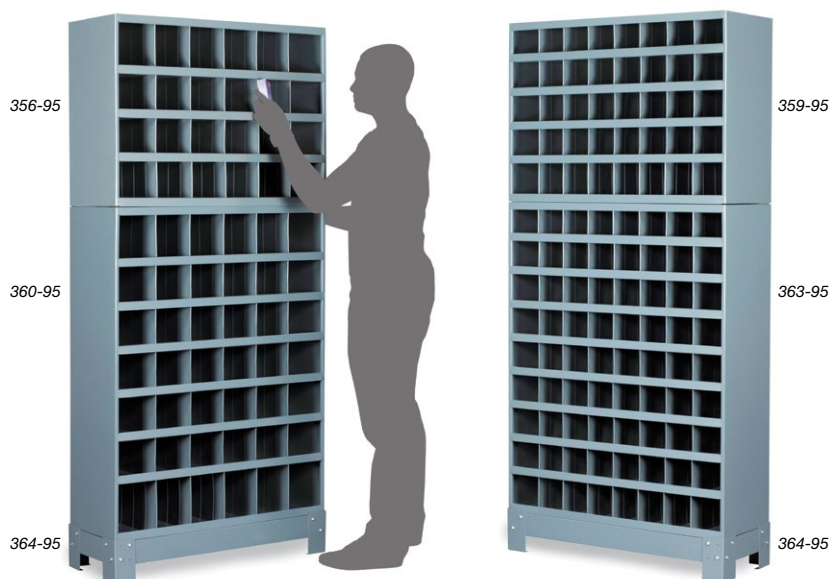

Description	Overall Dimensions H x W x D (mm)	No. Bins	Bin Dimensions H x W x D (mm)	Order Ref	Price (Each)
24 Compartment	606 x 857 x 304	24	139 x 136 x 301	356-95	£178.69
40 Compartment	606 x 857 x 304	40	114 x 101 x 301	359-95	£191.08
42 Compartment	1066 x 857 x 304	42	139 x 136 x 301	360-95	£284.85
72 Compartment	1066 x 857 x 304	72	114 x 101 x 301	363-95	£293.69
Bin Base	146 x 857 x 311	-	-	364-95	£76.08

## Drawer Cabinets

- Cold rolled steel construction
- High density drawer cabinet
- Drawers feature interlocking design for superior strength
- Drawers have full width handles and easy glide runners
- Each drawer includes two easy to label dividers
- Dividers are adjustable on 25mm centers
- Cabinets can be stacked using mounting holes
- Modular with other 857mm wide drawer cabinets and bins
- Optional base available
- Durable grey powder coat finish
- Supplied fully assembled



Description	Overall Dimensions H x W x D (mm)	No. Drawers	Drawer Dimensions H x W x D (mm)	Order Ref	Price (Each)
24 Drawer Cabinet	365 x 857 x 295	24	69 x 136 x 285	007-95	£249.46
30 Drawer Cabinet	450 x 857 x 295	30	69 x 136 x 285	014-95	£327.31
Drawer Cabinet Base	146 x 857 x 311	-	-	364-95	£76.08

## Topstore - Assortment Cases

Topstore assortment cases are compact and easy to handle. Both the case and compartments are manufactured from a strong and durable polypropylene.

The cases are supplied complete with either 12 or 18 compartments, each compartment is fully detachable from the case for easy selection. Each compartment can be clipped onto a belt which allows the user to have quick and easy access to the contents at all times.



### Topstore - Assortment Case c/w 12 Compartments

- Robust assortment case c/w 12 compartments
- Overall case dimensions (H) 340 x (W) 278 x (D) 145mm
- Overall compartment dimensions:  
6 no. Small Compartments (H) 66 x (W) 93 x (D) 74mm  
6 no. Large Compartments (H) 66 x (W) 153 x (D) 70mm



Description	Pack Qty	Order Ref	Price (per pack)
Assortment case c/w 12 compartments	5	QOC/3/5	£90.00

### Topstore - Assortment Case c/w 18 compartments

- Robust assortment case c/w 18 compartments
- Overall case dimensions (H) 340 x (W) 282 x (D) 145mm
- Overall compartment dimensions: (H) 70 x (W) 89 x (D) 81mm



Description	Pack Qty	Order Ref	Price (per pack)
Assortment case c/w 18 compartments	5	QOC/2/5	£90.00

## Topstore - Assortment Cases \_\_\_\_\_

These durable polypropylene assortment cases are ideal for storing small parts. Each case comes complete with a hinged clear lid which is ideal for easy product identification.

### Topstore - Assortment Case \_\_\_\_\_

- Compact and easy to handle
- 14 moulded sections (6 small & 8 large)
- Overall case dimensions (H) 45 x (W) 245 x (D) 180mm
- Overall section dimensions  
(H) 38 x (W) 57 x (D) 25mm (Small section)  
(H) 38 x (W) 60 x (D) 40mm (Large section)



Description	Pack Qty	Order Ref	Price (per pack)
Assortment Case c/w 14 moulded sections	20	QOC/1/20	£70.00

### Topstore - Assortment Case c/w 6 compartments \_\_\_\_\_

- Compact and easy to handle
- 6 fully removable compartments
- Compartments can be clipped onto a belt
- Overall case dimensions (H) 60 x (W) 215 x (D) 310mm
- Overall compartment dimensions (H) 55 x (W) 90 x (D) 68mm



Description	Pack Qty	Order Ref	Price (per pack)
Assortment Case c/w 6 compartments	10	QOC/5/10	£100.00

### Topstore - Assortment Case c/w 14 compartments \_\_\_\_\_

- Compact and easy to handle
- 14 fully removable compartments
- Compartments can be clipped onto a belt
- Overall case dimensions (H) 60 x (W) 380 x (D) 305mm
- Overall compartment dimensions (H) 55 x (W) 90 x (D) 68mm



Description	Pack Qty	Order Ref	Price (per pack)
Assortment Case c/w 14 compartments	5	QOC/4/5	£95.00

## Compartment Boxes

The compartment boxes are manufactured from cold rolled steel, and supplied with high impact styrene compartments. Each compartment has rounded scoop edges making it easy to remove small parts. Box lids are designed to stay open for easy access, and are fitted with a handle and pull-down catch.

- High impact styrene insert with various compartments
- Adjustable Compartment Box, comes complete with 4 fixed vertical compartments and 9 adjustable dividers.
- Full piano hinge on cover provides rigidity
- Positive pull-down catch keeps cover tightly closed to ensure all parts are secure in each section
- Handle allows for easy transport
- Durable grey powder coat finish



Description	Overall Dimensions H x W x D (mm)	Compartments	Pack Qty	Order Ref	Price (Per Pack)
20 Large Compartment Box	76 x 457 x 304	20	4	111-95	£107.68
24 Large Compartment Box	76 x 457 x 304	24	4	102-95	£107.68
32 Large Compartment Box	76 x 457 x 304	32	4	107-95	£107.68
Adjustable Compartment Box	76 x 457 x 304	Adjustable	4	119-95	£107.68

## Slide Rack & Base

- Sturdy construction using cold-rolled steel
- Fits in confined spaces
- Suits all 304mm deep compartment boxes
- Accommodates 4 large compartment boxes on telescopic 3 piece cradles
- Easy glide slides allow boxes to move in and out smoothly
- Each cradle holds up to 18Kg
- Centre braces on cradles provide extra rigidity
- Reinforced rack keeps boxes level
- Boxes can easily be removed for transport to work areas
- Base is available as an optional extra
- Durable grey power coat finish
- Compartment boxes are not included (please order separately).



Description	Overall Dimensions H x W x D (mm)	Compartments	Order Ref	Price (Each)
Slide Rack	381 x 514 x 317	4	310-95	£116.77
Slide Rack Base	396 x 523 x 320	-	311-95	£58.38



## Topstore - Topbox

Manufactured from polypropylene these containers are ideal for storing numerous items for the home, office and warehouse.

- Containers are available with and without clip-on lids
- Transparent container makes product selection easier
- Stackable with or without lids.
- Nestable



012455



012450 Stacked



012455 Nested

Product Description	Container Size: L x W x H (mm)	Order Ref	Pack Qty	Price (Per Pack)
24 Ltr Containers with Lids	430 x 325 x 245	012450/10	10	£65.40
24 Ltr Containers without Lids	420 x 315 x 241	012450/WOL/10	10	£49.70
35 Ltr Containers with Lids	490 x 395 x 260	012455/10	10	£94.23
35 Ltr Containers without Lids	483 x 382 x 257	012455/WOL/10	10	£68.90

BULK	Pallet Size: W x D x H (mm)	Order Ref	No. of containers per Bulk Pallet	Price (Per Pallet)
24 Ltr Containers with Lids	1200 x 1000 x 1850	012450/300	300	£1,478.70
35 Ltr Containers with Lids	1200 x 1000 x 1750	012455/180	180	£1,453.90

4 x 24Ltr Containers can be fitted to a trolley. Please refer to Container Trolleys (Ref DCT/4X24L) on page 42.

## Storemaster Box

The Storemaster Box is perfect for storing various items for the home, office or warehouse. Each container comes complete with two robust clips and a hinged folding lid for easy access, which also enables boxes to be stacked.

- Manufactured from a strong and durable co polymer
- Fully detachable hinged folding lids for easy access
- Robust clip shut locking handles
- Nestable when lids are not in use
- Stackable when lids are fitted
- Transparent container makes product selection easier



Product Description	L x W x H (mm)	Order Ref	Pack Qty	Price (Per Pack)
12 Ltr Storemaster Container c/w Hinged Lid	400 x 295 x 170	012470/10	10	£51.70
24 Ltr Storemaster Container c/w Hinged Lid	500 x 395 x 190	012471/10	10	£74.30
40 Ltr Storemaster Container c/w Hinged Lid	500 x 395 x 320	012472/10	10	£95.50
50 Ltr Storemaster Container c/w Hinged Lid	700 x 450 x 230	012473/10	10	£109.10

## Topstore - Space Bin Containers

Large robust polypropylene container that can either be stacked or nested.

- Ideal for separating goods
- Product selection made easy when stacked
- Designed to save space
- Each container capacity: 50 litres
- Maximum total stack height: 5 no.
- Maximum total stack load: 50Kg



Product Description	External H x W x D (mm)	Internal H x W x D (mm)	Order Ref	Pack Qty	Price (Each)
Space Bin Containers	320 x 495 x 390	320 x 440 x 340	E54SB/5	5	£52.50

BULK			
Order Ref	Pallet Size W x D x H (mm)	Pallet Qty	Price (Per Pallet)
E54SB/92	1200 x 800 x 2360	92	£810.00

## Topstore - Multi-functional Containers

Robust Multi-functional sorting storage bins complete with lids. With four colour options for the lids available.

- Ideal for separating items
- Manufactured from polypropylene
- Removable hinged lids
- Stackable/Nestable
- Can be used as colour coded bins for recycling items and segregation
- Each container capacity: 50 litres
- Maximum total stack height: 4 no.
- Maximum total stack load: 45Kg
- Containers are stackable with or without lids



052100/4

Product Description	H x W x D (mm)	Order Ref	Pack Qty	Price (Each)
Containers with Mixed Colour Lids	345 x 400 x 635	052100/4	4	£95.00
Containers with Blue Lids	345 x 400 x 635	052101/4	4	£95.00
Containers with Red Lids	345 x 400 x 635	052102/4	4	£95.00
Containers with Green Lids	345 x 400 x 635	052104/4	4	£95.00
Containers with Yellow Lids	345 x 400 x 635	052106/4	4	£95.00

BULK (60 bins & lids per pallet)			
Order Ref	Pallet Size W x D x H (mm)	Pallet Pack Qty	Price (Per Pallet)
052100/15	1130 x 1350 x 2030	15	£1,200.00
052101/15	1130 x 1350 x 2030	15	£1,200.00
052102/15	1130 x 1350 x 2030	15	£1,200.00
052104/15	1130 x 1350 x 2030	15	£1,200.00
052106/15	1130 x 1350 x 2030	15	£1,200.00

# Topstore - Euro Containers

Robust grey plastic containers that can interstack modularly with various sizes. Ideal for protective storage during transportation of goods. Lids and dollies can be supplied separately. All containers and accessories are manufactured from high-density food grade polypropylene which has a temperature resistance from -5°C to + 70°C.

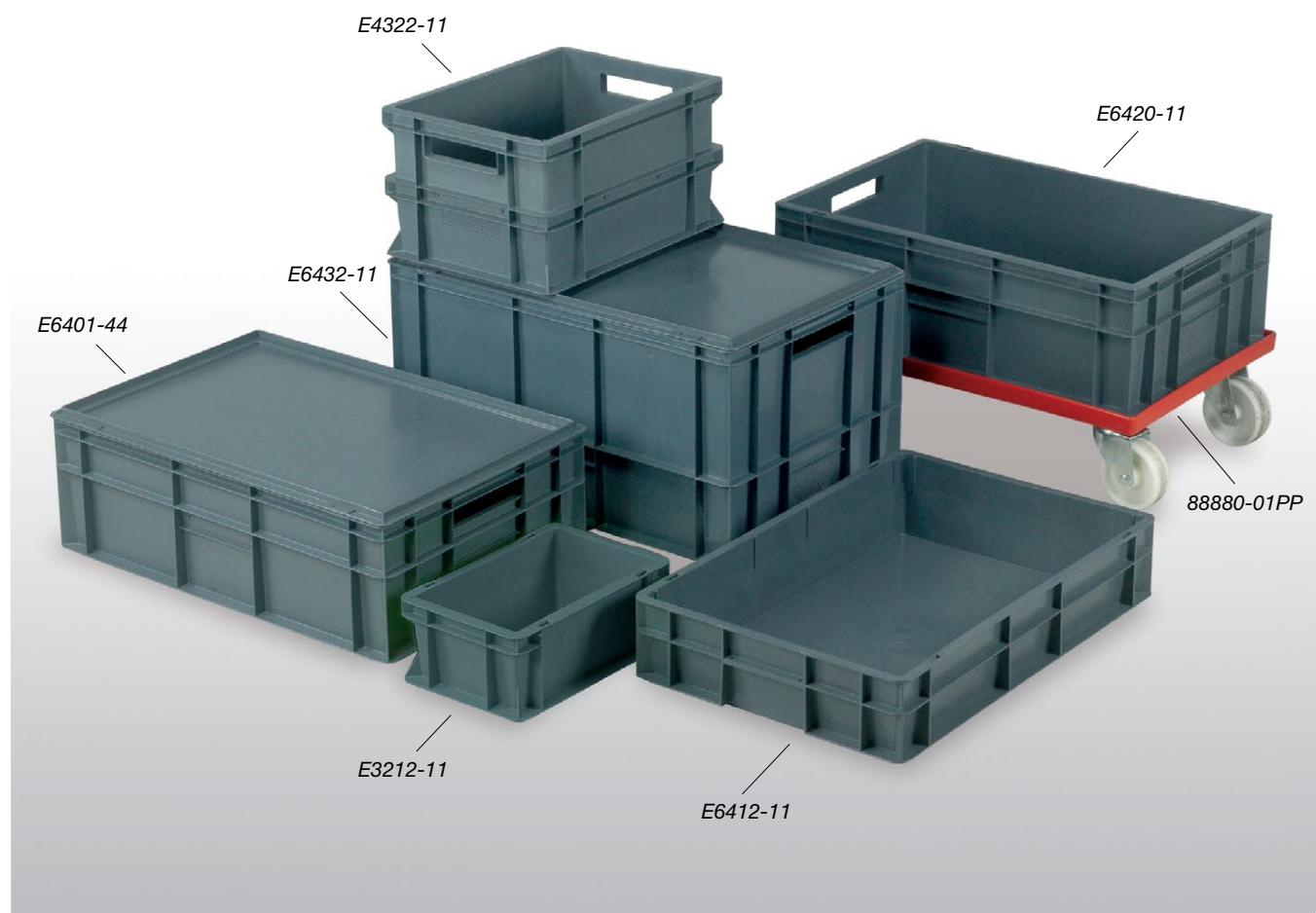

Product Description	External L x W x H (mm)	Internal L x W x D (mm)	Capacity (Kg)	Order Ref	Price (Each)
5 ltr	300 x 200 x 120	260 x 160 x 110	10	E3212-11	£5.79
10 ltr	400 x 300 x 120	356 x 256 x 110	15	E4312-11	£9.00
20 ltr	400 x 300 x 220	356 x 256 x 211	20	E4322-11	£12.27
22 ltr	600 x 400 x 120	555 x 358 x 105	20	E6412-11	£13.90
27 ltr	600 x 400 x 150	560 x 255 x 138	25	E6415-11	£14.00
30 ltr	600 x 400 x 170	560 x 360 x 157	25	E6417-11	£16.35
40 ltr	600 x 400 x 200	552 x 353 x 185	25	E6420-11	£16.40
52 ltr	600 x 400 x 270	560 x 358 x 257	25	E6427-11	£18.00
60 ltr	600 x 400 x 320	552 x 353 x 304	25	E6432-11	£20.94

BULK			
Order Ref	Pallet Height (mm)	Pallet Qty	Price (Per Pallet)
E3212-11/288	2120	288	£1,430.30
E4312-11/144	2040	144	£1,062.00
E4322-11/104	2090	104	£1,093.44
E6412-11/72	2100	72	£857.93
E6415-11/56	2040	56	£670.00
E6417-11/52	2200	52	£728.96
E6420-11/44	2210	44	£618.39
E6427-11/32	2040	32	£490.00
E6432-11/36	2080	36	£646.19

All Pallet Sizes - W x D (mm) - 1200 x 800

## Euro Container Lids

Lids are available in packs of 10, in two sizes to suit both (400x300mm) and (600x400mm) containers. These are drop-on lids (not hinged).

Product Description	Dimensions (mm)	Order Ref	Price (Per Pack)
Euro Container Lid - Dark Grey <i>Lid can fit all 400 x 300 Euro Containers</i>	400 x 300 x 19	E4301-44/10	£62.20
Euro Container Lid - Dark Grey <i>Lid can fit all 600 x 400 Euro Containers</i>	600 x 400 x 21	E6401-44/10	£80.80

## Stack & Nest Euro Containers

The unique design of these high quality Euro Containers allows them to be stacked or nested to save space when not in use. They are manufactured from high-density food grade polypropylene which is food grade and temperature resistant from -5°C to + 70°C.

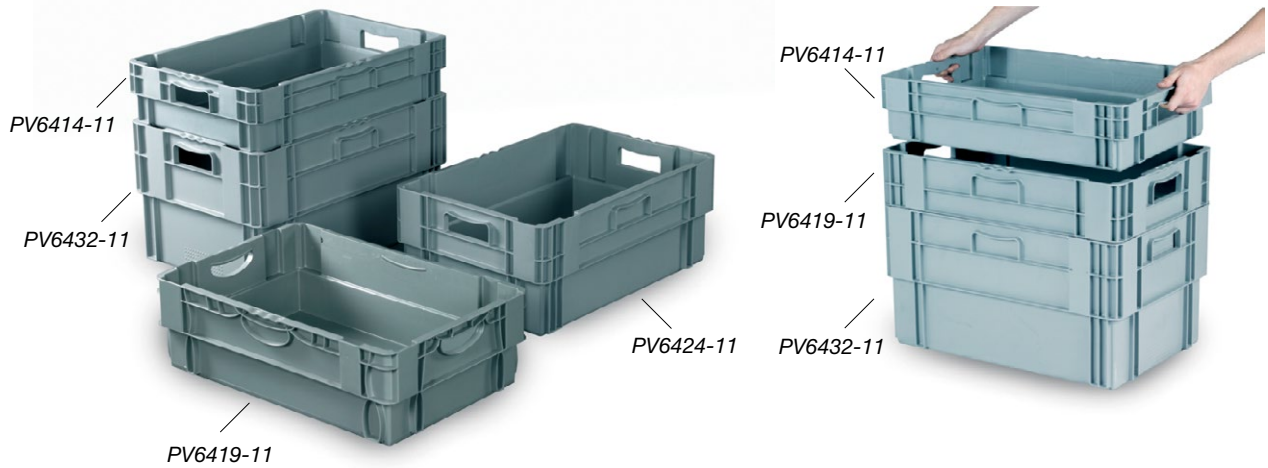

Product Description	External L x W x H (mm)	Internal L x W x H (mm)	Order Ref	Price (Each)	BULK			
					Order Ref	Pallet Height (mm)	Pallet Qty	Price (Per Pallet)
26 Ltr Nestable	600 x 400 x 140	557 x 356 x 130	PV6414 - 11	£17.00	PV6414-11/88	2040	88	£1,253.00
36 Ltr Nestable	600 x 400 x 190	554 x 356 x 172	PV6419 - 11	£18.50	PV6419-11/88	2040	88	£1,386.00
47 Ltr Nestable	600 x 400 x 240	558 x 356 x 228	PV6424 - 11	£22.00	PV6424-11/72	2040	72	£1,330.00
60 Ltr Nestable	600 x 400 x 320	556 x 356 x 307	PV6432 - 11	£26.00	PV6432-11/40	2040	40	£885.00

All Pallet Sizes - W x D (mm) - 1200 x 800

## Euro Container Dollies

Two ABS plastic dolly options are available with or without a handle, both capable of carrying up to 250Kg, perfect to transport multiple containers (Euro Containers or Stack and Nest Euro Containers) without causing excessive strain. It is fitted with 4 x swivel white nylon castors (100mm dia.) Load capacity with dolly and containers 250Kg, load capacity when handle is fitted 100Kg.

The steel handle, finished zinc and yellow passivated, can be adjusted in height and can be removed from dolly when not in use.



Product Description	External L x W x H (mm)	Internal L x W x H (mm)	Handle Length Min/Max (mm)	Without Handle		With Handle	
				Order Ref	Price (Each)	Order Ref	Price (Each)
Dolly	625 x 420 x 160	600 x 400	720 / 795	88880-01PP	£56.89	88880-01WH	£86.41
Dolly c/w 9 x 6412-11	625 x 420 x 1230	600 x 400	720 / 795	88880-01PP/6412	£170.00	88880-01WH/6412	£195.00
Dolly c/w 7 x 6417-11	625 x 420 x 1340	600 x 400	720 / 795	88880-01PP/6417	£160.00	88880-01WH/6417	£185.00
Dolly c/w 5 x 6420-11	625 x 420 x 1150	600 x 400	720 / 795	88880-01PP/6420	£140.00	88880-01WH/6420	£165.00
Dolly c/w 3 x 6432-11	625 x 420 x 1110	600 x 400	720 / 795	88880-01PP/6432	£120.00	88880-01WH/6432	£145.00

## Topstore – Euro Container Tray Trolleys

A choice of pre-kitted trolleys available complete with removable Euro Containers.

- Fully welded steel construction
- Handles fitted to aid manoeuvrability
- Rear safety stop fitted to retain Euro Containers when loading
- Epoxy powder coated silver/grey frame
- Wheels are all 100mm diameter swivel vulcanised blue rubber, offering low rolling resistance, meaning they are easy to manoeuvre, are non marking and soft yet highly durable.
- Braked or unbraked trolleys available (Braked versions have two braked castors)



Euro container sizes: (L x W x H)

E6412-11 (Ext: 600 x 400 x 120mm) (Int: 555 x 358 x 105mm)

E6417-11 (Ext: 600 x 400 x 170mm) (Int: 560 x 360 x 157mm)

E6420-11 (Ext: 600 x 400 x 200mm) (Int: 552 x 353 x 185mm)

**Trolley Height:** 1500mm

**Trolley Depth:** 700mm

**Trolley Width:** 470mm

**Max Trolley Capacity:** 250kg



ECT/8X6412/BC

ECT/6X6417/BC

ECT/6X6420/BC

Product Description	Load Capacity (Kg)	Braked Trolleys		Unbraked Trolleys	
		Order Ref	Price (Each)	Order Ref	Price (Each)
8 Tier - Euro Container c/w 8 x E6412-11	250	ECT/8X6412/BC	£410.00	ECT/8X6412	£400.00
6 Tier - Euro Container c/w 6 x E6417-11	250	ECT/6X6417/BC	£400.00	ECT/6X6417	£390.00
6 Tier - Euro Container c/w 6 x E6420-11	250	ECT/6X6420/BC	£410.00	ECT/6X6420	£400.00

## Topstore - Container Trolleys

A strong yet lightweight trolley designed to carry either NXT GEN, TC Topstore containers, mesh baskets or spigots and comes complete with a fixed lipped top tray. Attractively finished in epoxy powder coated silver/grey frame, would ideally be suited for any stores, office, workshop or warehouse.

Wheels are all 100mm diameter swivel vulcanised blue rubber, offering low rolling resistance, meaning they are easy to manoeuvre, are non marking and soft yet highly durable. Braked trolleys have two braked castors.

- All containers come complete with I.D labels.



Unbraked Castor



Braked Castor

**Trolley Height:** 1300mm

**Trolley Depth:** 500mm

**Trolley Width:** 500mm

**Max Trolley Capacity:** 200kg

See page 5 for Topstore TC Container dimensions and capacities

Supplied complete with a TP2 louvred panel.  
See pages 8 and 9 for full details.

Product Description	Braked Trolleys		Unbraked Trolleys	
	Order Ref	Price (Each)	Order Ref	Price (Each)
Container Trolley without Containers	CT/BC	£235.00	CT	£225.00
Container Trolley with 5 x TC6 Blue Containers	CT/5XTC6B/BC	£295.00	CT/5XTC6B	£285.00
Container Trolley with 5 x TC6 Red Containers	CT/5XTC6R/BC	£295.00	CT/5XTC6R	£285.00
Container Trolley with 5 x TC6 White Containers	CT/5XTC6E/BC	£295.00	CT/5XTC6E	£285.00
Container Trolley with 10 x TC5 Blue Containers	CT/10XTC5B/BC	£305.00	CT/10XTC5B	£295.00
Container Trolley with 10 x TC5 Red Containers	CT/10XTC5R/BC	£305.00	CT/10XTC5R	£295.00
Container Trolley with 10 x TC5 White Containers	CT/10XTC5E/BC	£305.00	CT/10XTC5E	£295.00
Container Trolley with 18 x TC3 Blue Containers	CT/18XTC3B/BC	£285.00	CT/18XTC3B	£275.00
Container Trolley with 18 x TC3 Red Containers	CT/18XTC3R/BC	£285.00	CT/18XTC3R	£275.00
Container Trolley with 18 x TC3 White Containers	CT/18XTC3E/BC	£285.00	CT/18XTC3E	£275.00
Container Trolley with 12 x TC4 Blue Containers	CT/12XTC4B/BC	£290.00	CT/12XTC4B	£280.00
Container Trolley with 12 x TC4 Red Containers	CT/12XTC4R/BC	£290.00	CT/12XTC4R	£280.00
Container Trolley with 12 x TC4 White Containers	CT/12XTC4E/BC	£290.00	CT/12XTC4E	£280.00
Container Trolley with 3 x Wire Mesh Baskets (460 x 330 x 200mm)	CT/3XLWB/BC	£390.00	CT/3XLWB	£370.00



CT/5XTC6B

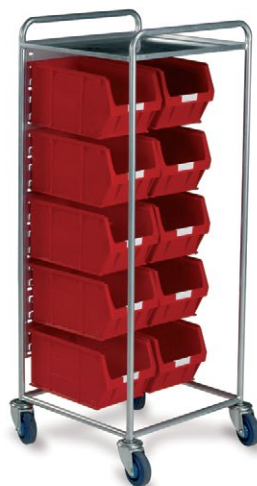

CT/10XTC5R



CT/18XTC3E



CT/3XLWB

# Topstore - Container Trolleys

An extended range of Container Trolleys fitted with a smaller louvred panel and 3 x fixed lipped trays to prevent stored items from slipping off. The trolley can either be supplied as complete kits with TC bins included or empty to suit individual requirements.

Wheels are all 100mm diameter swivel vulcanised blue rubber, offering low rolling resistance, meaning they are easy to manoeuvre, are non marking and soft yet highly durable. Braked trolleys have two braked castors.

- All containers come complete with I.D labels

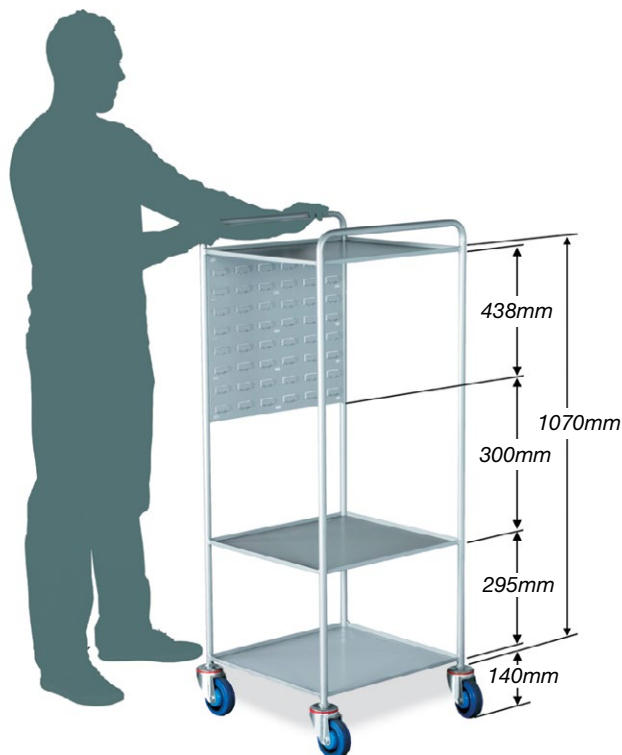

**Trolley Height:** 1300mm  
**Trolley Depth:** 500mm  
**Trolley Width:** 500mm  
**Max Trolley Capacity:** 200kg

See page 5 for Topstore TC Container dimensions and capacities

Supplied complete with a TP1 louvred panel. See pages 8 and 9 for full details.



CST Shelf/Tray  
 Tray size: W500 x D455mm

Product Description	Braked Trolleys		Unbraked Trolleys	
	Order Ref	Price (Each)	Order Ref	Price (Each)
Container Trolley Empty c/w 3 x Fixed Shelves	CST/BC	£265.00	CST	£255.00
Container Trolley c/w 4 x TC5 Blue & 3 x Fixed Shelves	CST/4XTC5B/BC	£285.00	CST/4XTC5B	£275.00
Container Trolley c/w 4 x TC5 Red & 3 x Fixed Shelves	CST/4XTC5R/BC	£285.00	CST/4XTC5R	£275.00
Container Trolley c/w 2 x TC6 Blue & 3 x Fixed Shelves	CST/2XTC6B/BC	£285.00	CST/2XTC6B	£275.00
Container Trolley c/w 2 x TC6 Red & 3 x Fixed Shelves	CST/2XTC6R/BC	£285.00	CST/2XTC6R	£275.00



CST/4XTC5B



CST/4XTC5R



CST/2XTC6B



CST/2XTC6R

## Topstore - Angled Container Trolley

An ideal way to transport small parts using either the Topstore TC Container range or Topstore Euro Container.

Its design offers easy access to all containers. Attractively finished in epoxy powder coated silver/grey frame, would ideally be suited for any stores, office, workshop or warehouse.

Wheels are 100mm diameter, all swivel vulcanised blue rubber, offering low rolling resistance, meaning they are easy to manoeuvre, are non marking and soft yet highly durable. Braked trolleys have two braked castors.

- All containers come complete with I.D labels



ACT/3XTC6B



ACT/3XEC

**Trolley Height:** 1030mm  
**Trolley Depth:** 830mm  
**Trolley Width:** 500mm  
**Max Trolley Capacity:** 200kg

See page 5 for Topstore TC Container dimensions and capacities.

See page 37 for Euro Container dimensions and capacities.

Product Description	Braked Trolleys		Unbraked Trolleys	
	Order Ref	Price (Each)	Order Ref	Price (Each)
Angled Container Trolley without Containers	ACT/BC	£225.00	ACT	£215.00
Angled Container Trolley with 3 x TC6 Blue Containers	ACT/3XTC6B/BC	£250.00	ACT/3XTC6B	£235.00
Angled Container Trolley with 3 x TC6 Red Containers	ACT/3XTC6R/BC	£250.00	ACT/3XTC6R	£235.00
Angled Container Trolley with 3 x TC6 White Containers	ACT/3XTC6E/BC	£250.00	ACT/3XTC6E	£235.00
Angled Container Trolley with 2 x (400 x 300 x 220) & 1 x (600 x 400 x 200mm) Grey Euro Containers	ACT/3XEC/BC	£265.00	ACT/3XEC	£255.00

## Topstore - Double Container Trolley

Designed to carry four 24 litre natural grade polypropylene storage containers and lids. Eliminates the need to carry heavy boxes and also saves time by allowing 4 to be transported at any one time.

Wheels are 100mm diameter, all swivel vulcanised blue rubber, offering low rolling resistance, meaning they are easy to manoeuvre, are non marking and soft yet highly durable. Braked trolleys have two braked castors.  
 Finish: Silver/Grey epoxy powder coated.



DCT/4X24L



**Trolley Height:** 1030mm  
**Trolley Depth:** 840mm  
**Trolley Width:** 480mm  
**Max Trolley Capacity:** 200kg

See page 35 for Topbox dimensions and capacities.

Product Description	Braked Trolleys		Unbraked Trolleys	
	Order Ref	Price (Each)	Order Ref	Price (Each)
Double Container Trolley without Containers	DCT/BC	£255.00	DCT	£245.00
Double Container Trolley with 4 x 24 Litre Plastic Containers	DCT/4X24L/BC	£280.00	DCT/4X24L	£270.00