

# WAREHOUSE / SAFETY / SITE MANAGEMENT

A wide range of Warehouse, Safety and Site Management products including Mezzanine Floors, Pallet Racking, Partitioning Guards, Barriers and Signage.

| <b>Product</b>  | <b>Lead Time</b><br>(Working Days) | <b>Page</b> |
|---|------------------------------------|-------------|
| Mezzanine Floors . . . . .  | (Please Enquire)                   | 172         |
| Mezzanine Handrail Netting and Pallet Nets . . . . .  | (Please Enquire)                   | 173         |
| Standard & Heavy Duty Adjustable Pallet Racking . . . . .   | (Please Enquire)                   | 174-175     |
| Rack Netting . . . . .  | (Please Enquire)                   | 176         |
| Anti-Collapse Mesh . . . . .  | (Please Enquire)                   | 177         |
| Titan, Elan and Sigma Partitioning . . . . .  | (Please Enquire)                   | 178-179     |
| Caelum Mesh Wall System . . . . .   | (Please Enquire)                   | 180         |
| GUARDA Chain Posts . . . . .  | (5)                                | 181         |
| Safety Barrier . . . . .  | (10-15)                            | 182-183     |
| Traffic-Line Steel Hoop Guards . . . . .  | (5-10)                             | 184-185     |
| Traffic-Line Protection Guards & FLEX Protection Guards . . . . .   | (5-10)                             | 186-187     |
| Traffic-Line FLEX Heavy Duty Bollards Traffic-Line Protection Guard<br>With Under-Run Protection. . . . . | (5-10)                             | 188         |
| Traffic-Line Collision Protection Guard . . . . .   | (5-10)                             | 189         |
| Traffic-Line Hi-Vis Belt Posts Traffic-Line Wall Mounted Belt<br>Cartridge & Accessories . . . . .        | (5-10)                             | 190 - 191   |
| Traffic-Line Impact Protection - Profiles . . . . .   | (5-10)                             | 192 - 193   |
| Traffic-Line Cable/Hose Protection Ramps, Topstop-Eco<br>Speed Reduction Ramps . . . . .                  | (5-10)                             | 194 - 195   |
| Spion Acrylic Mirrors & Panoramic Acrylic Mirrors . . . . .   | (5)                                | 196 - 197   |
| Detective-X Acrylic Convex Mirrors . . . . .  | (5)                                | 198         |
| Traffic-Line Bicycle Racks . . . . .  | (5)                                | 199         |
| Kenilworth & Premier Cycle Shelters . . . . .   | (5)                                | 200 - 201   |
| Proline Floor Marking System. . . . .   | (5)                                | 202 - 203   |
| Labels and Markers, Plastic Holders, Floor Signals<br>Graphic Markers & Racksacks . . . . .               | (5)                                | 204-207     |
| Packaging Products . . . . .  | (5)                                | 208         |



# Mezzanine Floors

Our mezzanine floors are manufactured to the highest quality and performance that comply with the latest British and European design standards.

Offering a fully comprehensive service from initial design and planning through to installation and commissioning, our mezzanine floors can help you maximise your building's capacity by taking advantage of unused vertical space.

Mezzanine floors can be a low cost option and are easily installed in almost every environment from a warehouse to a busy office.





## Mezzanine Handrail Netting

This simple and easy to install safety netting prevents items from being accidentally kicked or dropped protecting personnel on the floor below. Available in several colours of fire retardant net and using the wire fixing system, mezzanine guard rail nets are easy to install and incredibly easy to maintain. The net is constructed from 3mm cord and a 45mm mesh size. Comes complete with wires and fixings.

- Prevents items falling from a mezzanine floor
- Retains the use of the handrail
- Available in a choice of six colours
- For new installations or can be retrofitted



The price below is a guide.  
Prices for specific projects are available on request

|                                    |        |
|------------------------------------|--------|
| BUDGET PRICE<br>(per square metre) | £16.00 |
|------------------------------------|--------|

## Pallet Nets

This is ideal for any operation that requires secure transportation of products via a pallet

- Reuseable, no need for pallet wrap
- Reduces packaging costs
- Available in euro and standard pallet sizes
- Bungee cord base rope
- Environmentally friendly



The price below is guide. Specific prices for projects are available on request

|                               |          |        |
|-------------------------------|----------|--------|
| BUDGET PRICE (per pallet net) | Euro     | £46.95 |
|                               | Standard | £49.95 |

# Adjustable Pallet Racking

These pallet racking systems are designed from two basic components, frames and beams. In addition a range of accessories enable the system to meet a wide range of needs.

- Frames are of bolted construction and are supplied fully assembled.
- Beams are available in a range of lengths to suit both standard pallet sizes and bespoke pallets. Additionally the beams come in a range of profiles to meet the load requirements of almost any application.
- Beam safety locking clips are supplied with all beams in accordance with health and safety requirements.
- Frames are manufactured from galvatite steel or epoxy powder coated blue and beams are epoxy powder coated orange.
- Pallet racking accessories are available such as Pallet Support Bars, Fork Entry Bars, Rough Sawn Open and Closed Timber Decking, Upright Protection Guards, Rack End Barriers and Galvanised Steel Shelf Panels (please enquire).
- Manufactured in accordance with FEM standards.



Standard Duty Frames Ref:8808 (80mm x 80mm x 1.5mm) (Blue or Galvatite)

| Height | Depth   |         |
|--------|---------|---------|
|        | 900mm   | 1100mm  |
| 3000mm | £95.93  | £100.26 |
| 3500mm | £105.26 | £109.47 |
| 4000mm | £118.91 | £123.69 |
| 4500mm | £132.47 | £137.81 |
| 5000mm | £146.11 | £152.00 |
| 5500mm | £160.14 | £166.72 |
| 6000mm | £173.56 | £180.93 |

Heavy Duty Frames Ref:8813 (80mm x 80mm x 2.0mm) (Blue or Galvatite)

| Height | Depth   |         |
|--------|---------|---------|
|        | 900mm   | 1100mm  |
| 5000mm | £200.83 | £206.74 |
| 6000mm | £239.45 | £246.60 |
| 7000mm | £273.35 | £280.95 |

Frame Loading Capacities

| Distance From 1st Level to Floor | 8808 Frames (Kg) | 8813 Frames (Kg) | 8G15 Frames (Kg) |
|----------------------------------|------------------|------------------|------------------|
| 1000mm                           | 7200             | 15000            | 15000            |
| 1250mm                           | 7200             | 13600            | 13600            |
| 1500mm                           | 6400             | 12000            | 12000            |
| 1750mm                           | 6400             | 11200            | 11200            |
| 2000mm                           | 5600             | 10400            | 10400            |
| 2250mm                           | 5600             | 8800             | 8800             |

Beams (Orange)

| Length | Section            | Capacity UDL (Kg) Per Pair of Beams | Price (Each) |
|--------|--------------------|-------------------------------------|--------------|
| 1350mm | 84 (80mm x 40mm)   | 2200                                | £20.43       |
| 1850mm | 84 (80mm x 40mm)   | 2200                                | £26.58       |
| 2250mm | 94 (90mm x 40mm)   | 2000                                | £34.51       |
| 2700mm | 104 (100mm x 40mm) | 2400                                | £42.68       |
| 2700mm | 125 (120mm x 50mm) | 3600                                | £51.82       |
| 3300mm | 145 (140mm x 50mm) | 3600                                | £67.28       |
| 3600mm | 145 (140mm x 50mm) | 3200                                | £72.91       |
| 3900mm | 155 (150mm x 50mm) | 3400                                | £79.28       |

Accessories

| Description                     | Price (Each) |
|---------------------------------|--------------|
| Beam safety locking clips       | £0.37        |
| Shims 2mm                       | £1.78        |
| Row spacers 200mm               | £5.96        |
| Row spacers 300mm               | £7.53        |
| Floor fixing bolts 12mm x 70mm  | £0.60        |
| Floor fixing bolts 12mm x 100mm | £0.75        |
| Pallet support bars 900mm       | £19.82       |
| Pallet support bars 1100mm      | £21.96       |
| Fork entry bars 1200mm          | £27.55       |



# Galvanised Adjustable Pallet Racking



| Heavy Duty Frames Ref 8G15 (80mm x 80mm x 2.0mm) (Galvatite) |         |         |
|--|---------|---------|
| Height   | Depth   |         |
|  | 900mm   | 1100mm  |
| 3000mm   | £132.75 | £137.07 |
| 3500mm   | £148.21 | £152.41 |
| 4000mm   | £168.00 | £172.77 |
| 4500mm   | £187.78 | £193.12 |

For frame loading capacities see table on opposite page.

| Beams (Galvanised) |                    |                                     |              |
|--------------------|--------------------|-------------------------------------|--------------|
| Length             | Section            | Capacity UDL (Kg) Per Pair of Beams | Price (Each) |
| 1350mm             | 84 (80mm x 40mm)   | 2200                                | £29.90       |
| 1850mm             | 84 (80mm x 40mm)   | 2200                                | £39.05       |
| 2250mm             | 125 (120mm x 50mm) | 3000                                | £64.93       |
| 2700mm             | 125 (120mm x 50mm) | 3600                                | £76.54       |
| 3300mm             | 145 (140mm x 50mm) | 3600                                | £99.47       |

## Timber Decking

| Rough Sawn Open Board Timber Decking   | Untreated | Tanalised |
|--|-----------|-----------|
| 1340mm x 900mm x 32mm                  | £10.95    | £13.45    |
| 1340mm x 1100mm x 32mm                 | £12.95    | £15.45    |
| 1640mm x 900mm x 32mm                  | £13.95    | £16.45    |
| 1640mm x 1100mm x 32mm                 | £15.95    | £18.45    |
| Rough Sawn Closed Board Timber Decking | Untreated | Tanalised |
| 1340mm x 900mm x 32mm                  | £14.95    | £17.45    |
| 1340mm x 1100mm x 32mm                 | £16.95    | £19.45    |
| 1640mm x 900mm x 32mm                  | £17.95    | £20.45    |
| 1640mm x 1100mm x 32mm                 | £19.95    | £22.45    |



## Protection Guards & Barriers

| Description                               | Price (Each) |
|---|--------------|
| Upright protection guards (5mm) "L shape" | £29.95       |
| Upright protection guards (5mm) "U shape" | £34.95       |
| Tubular rack end barriers 1100mm          | £52.75       |
| Tubular rack end barriers 1200mm          | £55.75       |
| Tubular rack end barriers 2100mm          | £62.75       |
| Tubular rack end barriers 2500mm          | £68.75       |

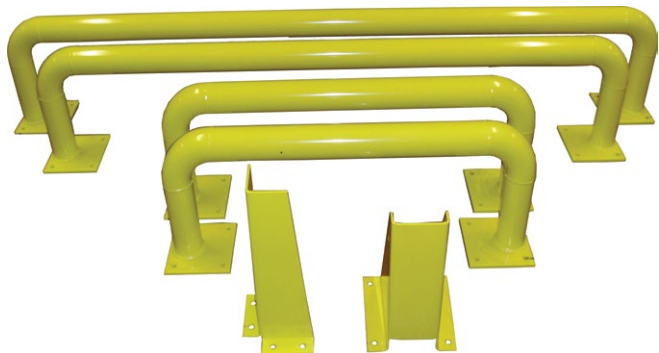

## Rack Netting

Rack Netting is a lightweight and surprisingly strong product that is perfect for a variety of safety applications around any industrial facility. Made from high density polypropylene the net is light weight and incredibly strong. A wide range of cord thicknesses and mesh sizes are available so that we can match your requirements with a specific net. The rack netting is also easy to install and does not suffer from corrosion.

### Back of Rack & Safety Netting

Back of rack safety netting is an excellent way of preventing injury and product damage at the back of single runs of pallet racking. Available in a small range of colours and strengths our unique bracket and fixing installation system prevents rack twisting and makes the net very quick to install.

- Prevents accidents and stock damage
- Withstands a full pallet impact at 1000kg
- Available in a choice of six colours
- Faster installation than traditional methods
- For new installations or can be retrofitted



|  |        |
|--|--------|
| The price below is guide.<br>Prices for specific projects are available on request |        |
| BUDGET PRICE<br>(per square metre)   | £18.00 |

### Spine Safety Netting

- Spine netting prevents items falling through double-entry racking
- For use in areas where ground pickers and truck operators work in close proximity
- Available in a choice of six colours

|  |        |
|--|--------|
| The price below is guide.<br>Prices for specific projects are available on request |        |
| BUDGET PRICE<br>(per square metre)   | £24.00 |





# Anti-Collapse Mesh

The Anti-Collapse system prevents any risk of spillage from pallets in warehouse storage, effectively protecting walkways and pallet rack aisles from unwanted accidents. This is a system that has been created for safe handling and storage of products in a warehouse / logistics environment.

A wide variety of panel sizes, stand-offs (from 50mm – 300mm), bracket types, and fixing kits ensure a safe and secure solution to accompany most pallet racking systems.

Our Anti-Collapse system is available in either hot dip galvanised or a variety of powder coated finishes.

Please contact us for a quote.



Racking Bracket



Ultima Bracket



Economy Bracket





# Titan Partitions



Titan is a high-quality, two-line double skinned partitioning system ideal for clean room applications. Its versatility allows it to be used for a variety of other applications including laboratories, hospitals, surgeries, and food preparation, but particularly those applications where appearance is important.

Titan can be multi-tiered and profiled for warehouse and office divisions to create an environment more appropriate for specialised areas; Titan can also be manufactured in a form that can more readily withstand moist atmospheres.

Titan partitioning has a two-line junction to keep dust traps to a minimum and its powder-coated finish is an ideal surface for clean environments. It is completely demountable, enabling panels to be removed without having to dismantle the entire structure.

All hardware accessories come in stainless steel as standard due to its exceptional "clean" properties, and flush glazing eliminates ledges and further improves aesthetics.

All joints can be silicone sealed to stop air loss and reduce particle traps. Additional aesthetic features such as integrated blinds with movable magnetic controls can be provided upon request, and options for extra sound reduction are available. There are also options for several different floor details including coved skirting, bull nosed skirting, and stainless steel kick plates.

Used in conjunction with the correct air handling and HVAC systems, a Class-5 clean room can be achieved (ISO 14611-1).

Ceilings are formed from a single-line junction panel with an optional facility that enables the ceiling to carry a load of one person - ideal for maintenance purposes.

Please contact us for a quote.



Integrated Blind with Control  
(Removable Magnetic Control available upon request)



Flush Glazing



Doors with Stainless Steel Fittings



## Elan Partitions

Elan is a high quality double-skin steel partitioning system for offices and warehouse factory applications where an attractive appearance is important. Panels are available in Full Steel and Steel/Glass combinations with double or single glazing.

Fully demountable, the panels can be supplied as fully fire-rated or non-fire rated. Additional noise reduction capabilities are available.

The Elan system can be supplied with a large range of ceilings (suspended or walk-on) and accessories. A wide variety of hinged and sliding doors are also available.



Elan and Sigma panels come in a wide range of sizes and heights allowing for multi-tiered configuration.

Both systems come in a variety of standard finishes (White RAL 9010. Sandstone BS08817. Grey BSDA005. Grey RAL 7037. Blue RAL 5010) and further non-standard, corporate and special finishes are available upon request.

Please contact us for a full quotation.

## Sigma Partitions

Sigma is a single-skin partitioning system suitable for factory, warehouse and storage requirements.

Fully demountable, it is ideal for enclosing work areas where appearance is important but without the cost of a double-skinned system. Sigma can also be used for machine guarding and for enclosing production lines, for perimeter guarding to automated machinery, robots, conveyors and with other automated processes. When used in a multi-tiered configuration it is effective for factory or warehouse division, providing additional security, dust-proofing and environmental control.

Sigma can be cut to accommodate existing structures providing an aesthetic finish. A variety of accessories such as drop-down hatches and framed openings can be created.

Sigma panels are available in full steel/glass, steel/mesh and all mesh combinations to suit your requirements, mesh can be provided in several styles and sizes. Furthermore a full range of hinged and sliding door options are available.





# Caelum Mesh Wall System

Caelum is a flexible system that can be used for a variety of purposes. A wide range of panel sizes with varying frame and mesh configurations ensure the perfect solution.

Caelum modular mesh panels can be used to build enclosures, boxes, storage units, and provide protection in automated warehouses, and are particularly useful in bonded stores, low-level and semi-secure storage areas and as small cage enclosures where high value retail goods (i.e. Smart phones, mobile telephones, tablets and laptops, computers, power tools, liquor, tobacco etc). Virtually any item that may require restricted accessibility can be stored.

The Caelum system is available in multi-tiered elevations, enabling the end user the ability to partition off large secure storage areas within warehouse environments, particularly useful for isolating and storing dangerous goods such as aerosols or combustible materials.

The Caelum Mesh Wall system is available in either hot dip galvanised, or a variety of powder coat finishes.

Please contact us for a quote.



Padlock & Hasp



Caelum Door



Digital Lock

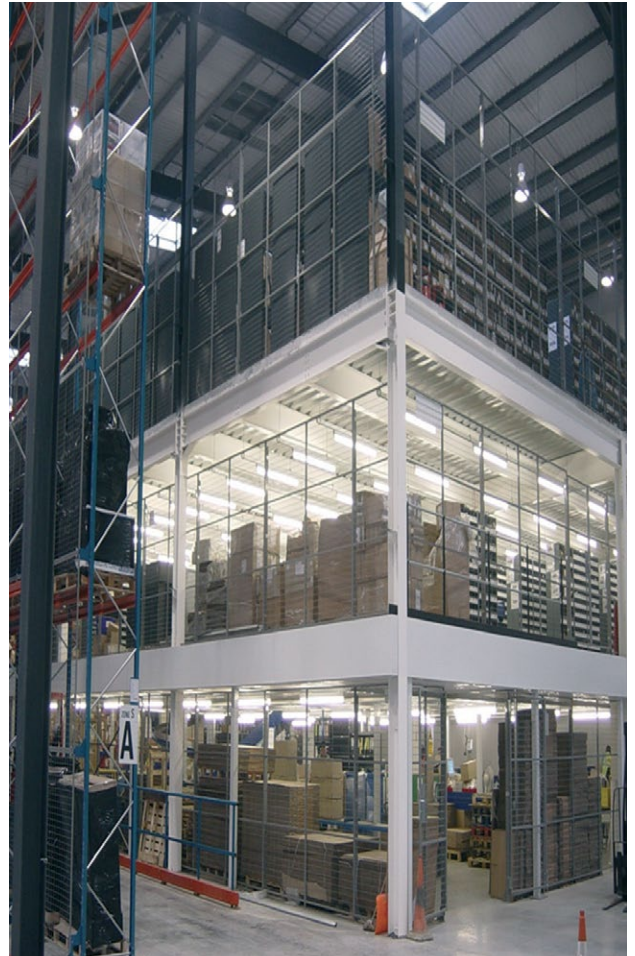



# GUARDA Chain Posts

GUARDA Chain Posts are the ideal low cost solution for cordoning off areas both internally and temporarily outdoors.

- Quickly and easily deployed.
- Corrosion proof plastic construction.
- Low centre of gravity for stability.
- Choice of three base styles.
- Four integrated chain eyes in cap.
- Highly visible post colours - Red/White or Black/Yellow

**Applications:**

Warehouse, production areas, shipping departments, administration depts. etc

**Specifications:**

Post dia. 40mm

Post height: 870mm

Bases:

Rubber: 265 x 265mm sq.

Weight 1.8kg

Plastic (hollow): 300mm dia.

Weight: Variable

Plastic/concrete\*: 300mm SL

Weight: 2.9kg

\*Suitable for outdoor use.

GUARDA Chain Post set.

As detailed above but available in handy sets of:

6 chain posts and bases.

10m of M-POLY Chain.

10 Connecting links.

10 'S' hooks.



| Chain stands<br>Plastic posts 40mm dia  | Base type                              | Colour       | Height (mm) | Base (mm) | Order Ref  | Price (Each) |
|---|--|--------------|-------------|-----------|------------|--------------|
|  | Plastic, concrete filled (three sided) | red/white    | 870         | 300 SL    | 175.13.895 | £8.00        |
|   |  | black/yellow |             |           | 175.14.011 | £8.00        |
|   | Hard rubber (four sided)               | red/white    |             | 265 x 265 | 175.19.222 | £11.50       |
|   |  | black/yellow |             |           | 175.16.601 | £11.50       |
|   | Plastic hollow (Round)                 | red/white    |             | 300       | 175.16.320 | £9.70        |
|   |  | black/yellow |             |           | 175.18.711 | £9.70        |

| Chain stand sets c/w 6 chain posts, 10m M-POLY Chain, 10 connecting links and 10 hooks | Base type                              | Colour       | Height (mm) | Base (mm) | Order Ref  | Price (Each) |
|--|--|--------------|-------------|-----------|------------|--------------|
|     | Plastic, concrete filled (three sided) | red/white    | 870         | 300 SL    | 175.16.146 | £73.30       |
|  |  | black/yellow |             |           | 175.13.735 | £73.30       |
|  | Hard rubber base (four sided)          | red/white    |             | 265 x 265 | 175.19.176 | £93.10       |
|  |  | black/yellow |             |           | 175.17.668 | £93.10       |
|  | Plastic hollow base (Round)            | red/white    |             | 300       | 175.15.850 | £83.00       |
|  |  | black/yellow |             |           | 175.17.247 | £83.00       |

# Safety Barriers

## Fully Welded Barriers

These safety barriers are designed for creating protective barriers around machinery and equipment and for defining walkways through industrial, manufacturing and warehousing areas.

- Choice of open or mesh infill panels.
- Fully welded construction.
- Powder coated high visibility yellow.
- Supplied with floor fixings.

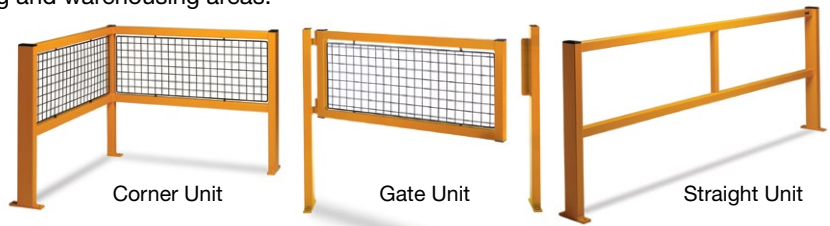

| Description   | Overall Size L x H (mm) | Mesh Infill  |         | Open Infill  |         |
|---------------|-------------------------|--------------|---------|--------------|---------|
|               |                         | Order Ref    | Price   | Order Ref    | Price   |
| Corner Unit   | 1200 x 900              | RBCU1290MYXX | £296.63 | RBCU1290OYXX | £200.59 |
|               | 1200 x 1100             | RBCU1211MYXX | £296.03 | RBCU1211OYXX | £203.21 |
| Gate Unit     | 900 x 900               | RBGU9090MYXX | £168.56 | RBGU9090OYXX | £131.81 |
|               | 900 x 1100              | RBGU9011MYXX | £175.95 | RBGU9011OYXX | £140.56 |
|               | 1200 x 900              | RBGU1290MYXX | £184.84 | RBGU1290OYXX | £138.69 |
|               | 1200 x 1100             | RBGU1211MYXX | £197.02 | RBGU1211OYXX | £149.84 |
| Straight Unit | 1200 x 900              | RBST1290MYXX | £187.02 | RBST1290OYXX | £141.72 |
|               | 1200 x 1100             | RBST1211MYXX | £236.02 | RBST1211OYXX | £181.74 |
|               | 2400 x 900              | RBST2490MYXX | £299.22 | RBST2490OYXX | £210.98 |
|               | 2400 x 1100             | RBST2411MYXX | £315.25 | RBST2411OYXX | £218.35 |

## Heavy Duty Barriers

These safety barriers are designed for creating protective barriers around machinery and equipment and for defining walkways through industrial, manufacturing and warehousing areas.

- 1400mm high for additional safety.
- Modular design.
- Welded support posts.
- Supplied in knock down form for easy onsite assembly.
- Powder coated red or yellow.
- Supplied with floor fixings.



| Description   | Size H (mm) | Red          | Yellow       | Price (Each) |
|---------------|-------------|--------------|--------------|--------------|
|               |             | Order Ref    | Order Ref    |              |
| Support Posts | 1400        | RBHDS1400RXX | RBHDS1400YXX | £142.91      |

| Description   | Size L (mm) | Red          | Yellow       | Price (Each) |
|---------------|-------------|--------------|--------------|--------------|
|               |             | Order Ref    | Order Ref    |              |
| Barrier Rails | 1500        | RBHDR1500RXX | RBHDR1500YXX | £90.94       |
|               | 1100        | RBHDR1100RXX | RBHDR1100YXX | £77.95       |
|               | 800         | RBHDRX800RXX | RBHDRX800YXX | £64.96       |
|               | 500         | RBHDRX500RXX | RBHDRX500YXX | £51.97       |



# Barriers

## Lift Out Barriers

- Modular design at 500, 900 or 1100mm tall.
- Removable rails allow access if required.
- Constructed from tough mild steel box section.
- Supplied in knock down form for easy onsite assembly.
- Powder coated high visibility yellow.
- Supplied with floor fixings.



Lift Out Single Rail Barrier

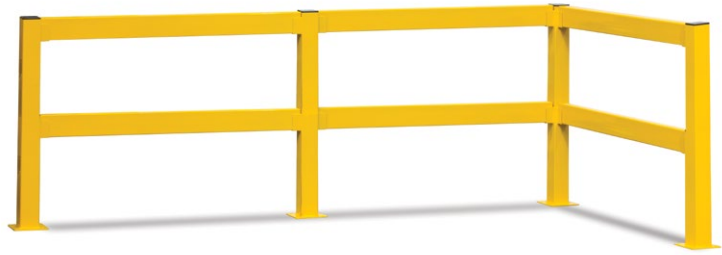

Lift Out Twin Rail Barrier

| Description             | Overall Size H x W x D (mm) | Order Ref    | Price (Each) |
|-------------------------|-----------------------------|--------------|--------------|
| Single Rail End Post    | 500 x 80 x 80               | RBSRBEX500Y  | £94.08       |
| SingleRailStandardPost  |                             | RBSRBBSX500Y | £108.64      |
| Single Rail Corner Post |                             | RBSRBBCX500Y | £108.64      |
| Twin Rail End Post      | 1100 x 80 x 80              | RBTRBBE1100Y | £122.08      |
|                         | 900 x 80 x 80               | RBTRBBEX900Y | £106.40      |
| Twin Rail Standard Post | 1100 x 80 x 80              | RBTRBBS1100Y | £136.64      |
|                         | 900 x 80 x 80               | RBTRBBSX900Y | £123.20      |

| Description           | Overall Size H x W x D (mm) | Order Ref    | Price (Each) |
|-----------------------|-----------------------------|--------------|--------------|
| Twin Rail Corner Post | 1100 x 80 x 80              | RBTRBBC1100Y | £136.64      |
|                       | 900 x 80 x 80               | RBTRBBCX900Y | £123.20      |
| Universal Rails       | 3000 Long                   | RBTRBBB3000Y | £126.56      |
|                       | 2400 Long                   | RBTRBBB2400Y | £107.52      |
|                       | 1200 Long                   | RBTRBBB1200Y | £84.00       |
|                       | 600 Long                    | RBTRBBB600Y  | £56.00       |
|                       | 300 Long                    | RBTRBBB300Y  | £39.20       |

## Round Tube Rail Barriers

- Modular design at 500 or 900mm tall.
- Supplied in knock down form for easy onsite assembly.
- Constructed from round tube beams and box section supports.
- Powder coated high visibility yellow.
- Supplied with floor fixings.

| Description                | Size (mm) | Order Ref    | Price (Each) |
|----------------------------|-----------|--------------|--------------|
| Single Rail End Post       | 500 High  | RBSRBREX500Y | £89.60       |
| SingleRailStandardPost     |           | RBSRBRSX500Y | £112.00      |
| Single Rail Corner Post    |           | RBSRBRCX500Y | £112.00      |
| Twin Rail End Post         | 900 High  | RBTRBREX900Y | £142.91      |
| Twin Rail Standard Post    |           | RBTRBRSX900Y | £172.79      |
| Twin Rail Corner Post      |           | RBTRBRCX900Y | £172.79      |
| Universal Round Tube Rails | 2000 Long | RBTRBRB2000Y | £64.96       |
|                            | 1600 Long | RBTRBRB1600Y | £51.96       |
|                            | 800 Long  | RBTRBRB800Y  | £38.96       |
|                            | 400 Long  | RBTRBRB400Y  | £25.98       |



Round Tube Single Rail Barrier



Round Tube Twin Rail Barrier

## Vision Barriers

- Light duty barrier system.
- Choice of sheet steel, clear perspex or mesh panels.
- Pre-drilled universal posts function as standard, corner and end posts
- Supplied in knock down form for easy onsite assembly.
- Powder coated yellow, can be supplied in black
- Supplied with floor fixings.



Mesh Clear Perspex Sheet Steel

| Description            | Size W x H (mm) | Yellow       | Black        | Price (Each) |
|------------------------|-----------------|--------------|--------------|--------------|
|                        |                 | Order Ref    | Order Ref    |              |
| Mesh Infill            | 990 x 1000      | RBVPM9910YXX | RBVPM9910AXX | £168.90      |
| Perspex Infill         |                 | RBVPX9910YXX | RBVPX9910AXX | £194.88      |
| Sheet Steel Infill     |                 | RBVPS9910YXX | RBVPS9910AXX | £142.91      |
| Universal Barrier Post | 1120 High       | RBVPP1120YXX | RBVPP1120AXX | £172.79      |

# TRAFFIC-LINE Steel Hoop Guards

Protect and segregate pedestrians, machinery and other zones from works vehicles, falls etc.

- Versatile and effective protection.
- Highly visible finish.
- Additional reinforcing crossbar.
- Easily installed with bolts (available at extra cost).

Permanent & removable versions now available for fixing to vertical surfaces.

**Applications:** Protection of pedestrian areas (entrances, exits etc.), machinery, dangerous zones, elevation changes, loading docks, hazardous areas, garage pits etc.

**Specifications:**

Lengths: 1,000, 1,500 and 2,000mm

Height: 1,000mm Surface mount –  
1,300mm Wall mounted

Diameter: 48mm Ø x 2mm Wall

Fixing plates: Surface mount -

70 x 60 x 10mm

(2 x mounting plates with pre-drilled fixing holes)

Wall fixing (permanent)

(2 x mounting plates with pre-drilled fixing holes)

Wall fixing (Removable)

(Socket with 2 x mounting plates with pre-drilled fixing holes)

**Finish:**

Interior: Powder coated yellow with black bands.

Exterior: Hot Dip Galvanised. Powder coated yellow with black bands.



Wall Mounted

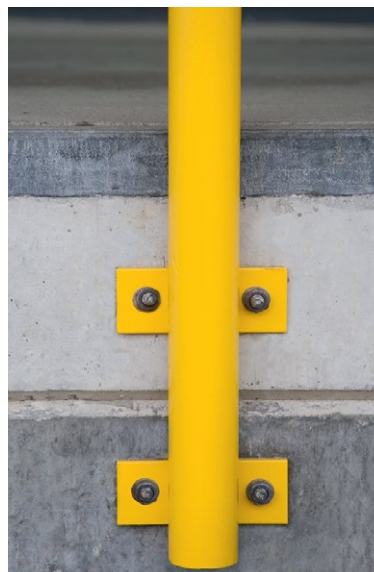

Permanent version



Removable version



# TRAFFIC-LINE Steel Hoop Guards

| Steel Hoop Guards 48/2mm Surface Fixing 160 x 70 x 10mm                           | Description             | Dimensions H x L (mm) | Finish                               | Order Ref  | Price (Each) |
|---|-------------------------|-----------------------|--------------------------------------|------------|--------------|
|  | Yellow with black bands | 1000 x 1000           | Powder Coated                        | 201.14.228 | £131.40      |
|   |                         |                       | Hot dip galvanised and powder coated | 201.15.512 | £165.50      |
|   |                         | 1000 x 1500           | Powder Coated                        | 201.15.794 | £156.00      |
|   |                         |                       | Hot dip galvanised and powder coated | 201.17.982 | £196.40      |
|   |                         | 1000 x 2000           | Powder Coated                        | 201.14.465 | £175.90      |
|   |                         |                       | Hot dip galvanised and powder coated | 201.13.553 | £223.90      |

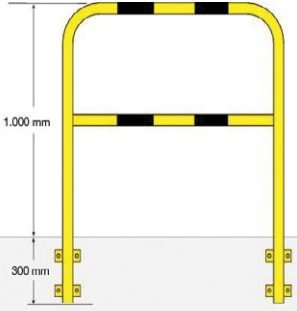
| Steel Hoop Guards 48/2mm Wall Fixing (Permanent) 160x70x10mm                       | Description              | Dimensions H x L (mm) | Finish                               | Order Ref  | Price (Each) |
|--|--------------------------|-----------------------|--------------------------------------|------------|--------------|
|  | Wall fixings (permanent) | 1300 x 1000           | Powder Coated                        | 201.23.846 | £174.90      |
|  |                          |                       | Hot dip galvanised and powder coated | 201.23.287 | £205.70      |
|  |                          | 1300 x 1500           | Powder Coated                        | 201.21.475 | £201.90      |
|  |                          |                       | Hot dip galvanised and powder coated | 201.27.174 | £213.10      |
|  |                          | 1300 x 2000           | Powder Coated                        | 201.20.276 | £224.50      |
|  |                          |                       | Hot dip galvanised and powder coated | 201.24.456 | £267.20      |

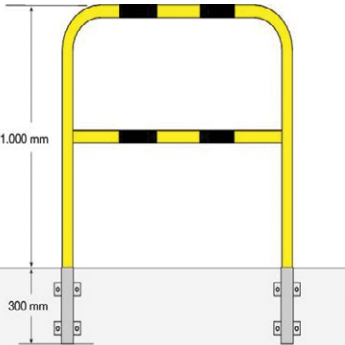
| Steel Hoop Guards 48/2mm Wall Fixing (Removable) 160x70x10mm                        | Description                      | Dimensions H x L (mm) | Finish                               | Order Ref  | Price (Each) |
|---|----------------------------------|-----------------------|--------------------------------------|------------|--------------|
|  | Wall fixings (removable barrier) | 1300 x 1000           | Powder Coated                        | 201.25.003 | £136.00      |
|   |                                  |                       | Hot dip galvanised and powder coated | 201.20.059 | £168.60      |
|   |                                  | 1300 x 1500           | Powder Coated                        | 201.22.243 | £162.90      |
|   |                                  |                       | Hot dip galvanised and powder coated | 201.27.829 | £201.40      |
|   |                                  | 1300 x 2000           | Powder Coated                        | 201.21.658 | £185.50      |
|   |                                  |                       | Hot dip galvanised and powder coated | 201.21.335 | £230.10      |
| Rawl plug bolt (4 per guard)  |                                  | 12 x 100              | -                                    | 100.17.393 | £1.50        |
| Throughbolt anchor  |                                  | 12 x 120              | -                                    | 100.24.665 | £3.00        |
| Wall socket   |                                  | 120W x 300H           | Hot dip galvanised                   | 201.27.454 | £34.60       |

# TRAFFIC-LINE Protection Guards

Protect property and machinery with TRAFFIC-LINE Protection Guards.

- Superior build quality and strength.
- Highly visible colour scheme.
- Easily installed with floor fixings (available at extra cost)
- Corner protection style also available with 600mmL sides.

Applications: Protect stock, traffic routes and work areas, separates different traffic routes (e.g. stacker lanes in warehouses and pedestrian traffic), machinery, supports, columns, shelving, loading ramps, equipment etc.

**Specification:**

Widths: 375mm, 750mm and 1,000mm.  
 Heights: 350mm, 600mm and 1,200mm.  
 Diameter: 76mm with 3mm wall thickness.  
 Fixing plates: 160 x 140 x 10mm (drilled 4 fixing holes)

**Finishes:**

Interior: Powder coated yellow with black bands.  
 Exterior: Hot Dip Galvanised. Powder coated yellow with black bands.

Sub-surface versions, special sizes and colours can be manufactured to order.



| Steel guards 76/3.0mm<br>Surface fixing plate 160 x 140 x 10mm | Colour                  | Dimensions<br>H x W (mm) | Finish                               | Order Ref  | Price (Each) |
|--|-------------------------|--------------------------|--------------------------------------|------------|--------------|
|  | Yellow                  | 350 x 375                | Powder coated                        | 195.15.621 | £98.30       |
|  |                         |                          | Hot dip galvanised and powder coated | 195.18.233 | £122.40      |
|  | Yellow with black bands | 350 x 750                | Powder coated                        | 195.14.450 | £115.00      |
|  |                         |                          | Hot dip galvanised and powder coated | 195.16.265 | £140.60      |
|  |                         | 350 x 1000               | Powder coated                        | 195.14.589 | £124.00      |
|  |                         |                          | Hot dip galvanised and powder coated | 195.13.499 | £154.10      |
|  |                         | 600 x 750                | Powder coated                        | 195.18.515 | £136.70      |
|  |                         |                          | Hot dip galvanised and powder coated | 195.17.623 | £170.60      |
|  |                         | 600 x 1000               | Powder coated                        | 195.18.943 | £146.80      |
|  |                         |                          | Hot dip galvanised and powder coated | 195.19.157 | £182.80      |
|  |                         | 1200 x 750               | Powder coated                        | 195.19.573 | £173.70      |
|  |                         |                          | Hot dip galvanised and powder coated | 195.17.296 | £215.80      |
|  |                         | 1200 x 1000              | Powder coated                        | 195.17.903 | £186.40      |
|  |                         |                          | Hot dip galvanised and powder coated | 195.18.822 | £232.60      |
| Rawl plug bolt   | 8 required per guard    | 12 x 100                 | -                                    | 100.17.393 | £1.50        |
| Throughbolt anchor   |                         | 12 x 120                 | -                                    | 100.24.665 | £3.00        |

Sub-surface versions available upon on request

| Steel guards 76/3.0mm<br>Surface fixing plate 160 x 140 x 10mm | Colour                  | Dimensions<br>H x W (mm) | Finish                               | Order Ref  | Price (Each) |
|--|-------------------------|--------------------------|--------------------------------------|------------|--------------|
|  | Yellow with black bands | 350 x 600                | Powder coated                        | 195.13.241 | £198.90      |
|  |                         |                          | Hot dip galvanised and powder coated | 195.14.708 | £258.90      |
|  |                         | 600 x 600                | Powder coated                        | 195.14.637 | £242.70      |
|  |                         |                          | Hot dip galvanised and powder coated | 195.17.083 | £316.00      |
|  |                         | 1200 x 600               | Powder coated                        | 195.17.512 | £316.60      |
|  |                         |                          | Hot dip galvanised and powder coated | 195.13.874 | £381.80      |
| Rawl plug bolt   | 12 required per guard   | 12 x 100                 | -                                    | 11.17.393  | £1.50        |
| Throughbolt anchor   |                         | 12 x 120                 | -                                    | 100.24.665 | £3.00        |



# TRAFFIC-LINE FLEX Protection Guards

## TRAFFIC-LINE FLEX Protection Guards

A unique development of our standard Protection Guards that features the strength and protective attributes of steel combined with the ability to 'give' up to 10 degrees from the vertical, reducing the incidence of damage and the need for repairs. This is achieved by equipping the guard with flexible shock absorbing polyurethane pads. These pads are UV, weather and temperature resistant, making them suitable for internal and external use.

- Highly visible yellow/black colour scheme.
- Unique flexing action.
- Easily installed.
- Interior & Exterior models.

### Applications:

Traffic routes and work areas, segregation of traffic routes, machinery, supports, columns, loading ramps, equipment etc.

### Specifications:

Widths: 375, 750, 1,000 and 2,000mm

Heights (max. inclination): 390 (55), 640 (95), 1240 (190)mm

Diameter: 76mm

Wall thickness: 3mm

### Finishes:

Interior: Powder coated yellow with black bands

Exterior: Hot Dip Galvanised, Powder coated yellow with black bands

Upgradable: Existing TRAFFIC-LINE Protection Guard installations can be up-graded, new chemi-anchor fixings will be required.

Options: Can be supplied in a sub-surface fixing version – POA.



| Steel guards 76/3.0mm<br>Surface fixing plate 16t0x140x10mm | Colour                               | Dimensions<br>H x W (mm) | Finish                               | Order Ref  | Price (Each) |
|---|--------------------------------------|--------------------------|--------------------------------------|------------|--------------|
|   | Yellow                               | 390 x 375                | Powder coated                        | 196.21.558 | £132.60      |
|   |                                      |                          | Hot dip galvanised and powder coated | 196.24.195 | £153.90      |
|   | Yellow with black bands              | 390 x 750                | Powder coated                        | 196.23.927 | £146.80      |
|   |                                      |                          | Hot dip galvanised and powder coated | 196.28.870 | £172.00      |
|   |                                      | 390 x 1000               | Powder coated                        | 196.20.479 | £158.40      |
|   |                                      |                          | Hot dip galvanised and powder coated | 196.28.678 | £185.50      |
|   |                                      | 390 x 2000               | Powder coated                        | 196.23.138 | £221.00      |
|   |                                      |                          | Hot dip galvanised and powder coated | 196.29.639 | £248.00      |
|   |                                      | 640 x 750                | Powder coated                        | 196.27.339 | £171.10      |
|   |                                      |                          | Hot dip galvanised and powder coated | 196.26.638 | £190.40      |
|   |                                      | 640 x 1000               | Powder coated                        | 196.29.617 | £181.10      |
|   |                                      |                          | Hot dip galvanised and powder coated | 196.20.921 | £214.20      |
|   |                                      | 640 x 2000               | Powder coated                        | 196.28.884 | £241.30      |
|   |                                      |                          | Hot dip galvanised and powder coated | 196.20.921 | £276.70      |
|   |                                      | 1240 x 750               | Powder coated                        | 196.21.978 | £208.10      |
|   |                                      |                          | Hot dip galvanised and powder coated | 196.23.976 | £247.20      |
|   |                                      | 1240 x 1000              | Powder coated                        | 196.21.739 | £220.80      |
|   |                                      |                          | Hot dip galvanised and powder coated | 196.29.532 | £264.00      |
| 1240 x 2000   | Powder coated                        | 196.27.054               | £289.10                              |            |              |
|   | Hot dip galvanised and powder coated | 196.22.922               | £331.80                              |            |              |
| Chemical Anchors  |                                      | 300 x 100                | -                                    | 100.20.858 | £55.00       |

## TRAFFIC-LINE FLEX Heavy Duty Bollards

The “smart” protection bollard – yields when hit helping to reduce damage to both the bollard and the vehicle. Combination of internal spring and an elastic polyurethane buffer absorbs the impact force (progressive force absorption).

- Heavy duty protection.
- “Gives” up to 25°.
- Returns to original position.
- Superior build quality and strength.
- High grade steel construction.

**Applications:** High traffic areas, loading bays, site entrances, etc.

**Specification:**

Material: Steel/Polyurethane construction.

Height: 655mm

Diameter: 159mm



Wall thickness: 4.5mm

Fixing plate: 200 x 200 x 10mmD (pre-drilled 4 holes)

Finish:

Interior: Powder coated Yellow

Exterior: Hot Dip Galvanised. Powder coated Yellow

| Flexible steel bollard 159/4.5mm<br>Surface fixing 200 x 200 x 100mm              | Colour                  | Dimensions (mm)<br>H x Ø | Finish                               | Order Ref  | Price (Each) |
|---|-------------------------|--------------------------|--------------------------------------|------------|--------------|
|  | Yellow with black bands | 655 x 159                | Powder coated                        | 199.29.230 | £262.60      |
|   |                         |                          | Hot dip galvanized and powder coated | 199.28.240 | £297.80      |
| Rawl plug bolt  | 4 per guard             | 12 / 100                 | -                                    | 100.17.393 | £1.50        |
| Throughbolt anchor  |                         | 12 / 120                 | -                                    | 100.24.665 | £3.00        |
|  | Root fixing adapter     | Size<br>200 x 200 x 10   | Hot dip galvanized                   | 199.28.682 | £44.60       |
|   |                         | Diam<br>Ø 76             |                                      |            |              |

## TRAFFIC-LINE Protection Guard with Under-Run Protection



**TRAFFIC-LINE Protection Guard with Under-Run Protection** Same design as **TRAFFIC-LINE**. Protection Guards but with steel infill plate.

- Superior build quality and strength.
- Strong, effective protection.
- Protect vulnerable equipment.
- Highly visible colour scheme.
- Easily installed with 8 anchor bolts (available at extra cost).

Diameter: 76mm x 3mm wall thickness

Fixing plates: 160 x 140 x 10mm (drilled 4 fixing holes)

**Under-run plate:**

Height: 150mm and 400mm

Gauge: 4mm

Finish: Powder coated yellow with black bands.

Sub-surface versions, special sizes and colours can be manufactured to order. Please ask for details.

**Applications:**

Use in warehouses, distribution depots, storage areas etc.

**Specification:**

Widths: 750mm and 1,000mm

Heights: 350mm and 600mm

| Steel protection guard 76/30mm with under-run protection plate 4.0mm gauge surface fixing | Colour               | Dimensions H x W (mm) | Finish                                  | Order Ref  | Price (Each) |
|---|----------------------|-----------------------|---|------------|--------------|
|        | 150                  | 350 x 750             | Powder Coated - yellow with black bands | 196.16.857 | £160.30      |
|   |                      | 350 x 1000            |   | 196.15.132 | £175.10      |
|   | 400                  | 600 x 750             |   | 196.17.125 | £229.50      |
|   |                      | 600 x 1000            |   | 196.17.619 | £270.70      |
| Rawl plug bolt  | 8 required per guard | 12 x 100              | -                                       | 100.17.393 | £1.50        |
| Throughbolt anchor  |                      | 12 x 120              | -                                       | 100.24.665 | £3.00        |



# TRAFFIC-LINE Collision Protection Guard

Low cost protection for plant and machinery from forklift trucks, roller containers, trolleys, pallet trucks etc.

- Easily and quickly installed.
- Low profile design enables easy pedestrian access to protected areas.
- Protect machinery, plant etc
- Interior use only

Applications: Protect shelving, cabinets, wall-mounted equipment (instruments, switch cabinets, first aid equipment etc.).

**Specification:**

Lengths: 400, 800 and 1,200mm.  
 Height (O/all): 86mm  
 Diameter: 76mm with 3mm wall thickness.  
 Base plates: 10mm thick. Drilled 2 fixing holes.  
 Finish: Powder coated yellow with black bands.

Special lengths, colours, and external versions can be manufactured to order. Please ask for details.

Corner Protection Collision guards – 638mm each arm.

Dimensions: 86 x 638 x 638mm.



| Steel protection guard 76/3mm for surface mounting (130 x 70 x 10mm) | Colour                  | Dimensions H x W (mm) | Finish        | Order Ref  | Price (Each) |
|--|-------------------------|-----------------------|---------------|------------|--------------|
|  | Yellow with black bands | 86 x 400              | Powder Coated | 195.13.478 | £27.90       |
|  |                         | 86 x 800              |               | 195.19.220 | £43.50       |
|  |                         | 86 x 1200             |               | 195.14.143 | £59.40       |
| Rawl Plug bolt   | 4 required per guard    | 12 x 100              | -             | 100.17.393 | £1.50        |
| Throughbolt anchor   |                         | 12 x 120              | -             | 100.24.665 | £3.20        |

| Corner steel protection guard 76/3mm for surface mounting (130 x 70 x 10mm) | Colour                  | Dimensions H x W (mm) | Finish        | Order Ref  | Price (Each) |
|---|-------------------------|-----------------------|---------------|------------|--------------|
|   | Yellow with black bands | 86 x 638 x 638        | Powder Coated | 199.22.677 | £114.10      |
| Rawl Plug bolt  | 6 required per guard    | 12 x 100              | -             | 100.17.393 | £1.50        |
| Throughbolt anchor  |                         | 12 x 100              | -             | 100.24.665 | £3.20        |

# TRAFFIC-LINE Hi-Vis Belt Posts

A supremely flexible system that provides either permanent or temporary demarcation of pedestrian areas from vehicular traffic routes.

- Quickly & easily deployed.
- High visibility colour scheme.
- Moulded bases with reflectors.
- Temporary or permanent installation.
- Base can be weighted with water or sand.
- Powder coated aluminium posts.
- Self tensioning mechanism.
- Damped belt mechanism for controlled retraction.
- Secure four point fixing for permanent installations.  
(Fixing bolts available at extra cost.)

**Specification:**

- Overall height: 985mm
- Post dia.: 60mm
- Post colours: Yellow, Red
  
- Weight: 13kg (filled) 2.4kg (empty)
- Base dia.: 330mm
- Base colours: Yellow/Black, Red/White
  
- Belt length: 3000mm or 4000mm
- Belt colours: Black/Yellow diagonal stripes.
- Red/White diagonal stripes.
- Or single colours available.
  
- **Applications:**
- Barriers,
- Guidance,
- Parking facilities,
- Industrial premises,
- Warehouses,
- Outdoor facilities, etc.



| Description   | Colours              | Belt length (mm) | Order Ref  | Price (Each) |            |         |
|---|----------------------|------------------|------------|--------------|------------|---------|
|  | Yellow powder coated | Black/Yellow     | 3000       | 179.14.759   | £154.20    |         |
|   |                      | Black/Yellow     | 4000       | 179.22.511   | £171.40    |         |
|   | Red powder coated    | Yellow           | Yellow     | 3000         | 179.17.353 | £154.20 |
|   |                      |                  | Yellow     | 4000         | 179.26.335 | £171.40 |
|   |                      | Red/White        | Red/White  | 3000         | 179.19.970 | £154.20 |
|   |                      |                  | Red/White  | 4000         | 179.28.338 | £171.40 |
| Red   | Red                  | 3000             | 179.15.362 | £154.20      |            |         |
|   | Red                  | 4000             | 179.24.575 | £171.40      |            |         |



# TRAFFIC-LINE Wall Mounted Belt Cartridge

The TRAFFIC-LINE Wall Mounted Belt Cartridge is available in both conventional fixing and in Magnetic fixing versions, giving them a greater flexibility in use.

The ideal solution for controlling access at fixed locations.

- Easy to install.
- Moulded in black hard wearing ABS.
- Damped belt action for smooth retraction.
- Unique bracket allows belt deployment in three directions.
- Choose from 5 belt colours.
- The belts are manufactured from a strong and durable fabric.

**Applications:**







Entrances, internal door-ways, stairs, corridors, aisles etc.







**Specifications:**

Cartridge height: 130mm  
 Cartridge depth: 110mm  
 Belt length: 3000mm or 4000mm  
 Belt width: 50mm

**Accessories:** Wall mounted clip, Belt joining clip.



| Wall mounted belt cartridge (H) 130mm (D) 110mm cartridge colour black             | Colours   |                      | Belt length (mm) | Order Ref  | Price (Each) |
|--|---|----------------------|------------------|------------|--------------|
|  |    | black/yellow striped | 3000             | 179.18.124 | £79.00       |
|  |   |                      | 4000             | 179.23.024 | £96.50       |
|  |    | red/white striped    | 3000             | 179.13.738 | £79.00       |
|  |   |                      | 4000             | 179.23.085 | £96.50       |
|  |    | black/yellow/black   | 3000             | 179.19.708 | £79.00       |
|  |   |                      | 4000             | 179.29.337 | £96.50       |
|  |  | black/red/black      | 3000             | 179.16.023 | £79.00       |
|  |   |                      | 4000             | 179.26.981 | £96.50       |
|  |  | black/silver/black   | 3000             | 179.18.931 | £79.00       |
|  |   |                      | 4000             | 179.29.945 | £96.50       |

| Magnetic belt cartridge (H) 130mm (D) 110mm cartridge colour black                  | Colours   |                      | Belt length (mm) | Order Ref  | Price (Each) |
|---|---|----------------------|------------------|------------|--------------|
|  |  | black/yellow striped | 3000             | 179.27.462 | £101.00      |
|   |   |                      | 4000             | 179.23.187 | £124.40      |
|   |  | red/white striped    | 3000             | 179.27.835 | £101.00      |
|   |   |                      | 4000             | 179.21.407 | £124.40      |
|   |  | black/yellow/black   | 3000             | 179.20.545 | £101.00      |
|   |   |                      | 4000             | 179.29.326 | £124.40      |
|   |  | black/red/black      | 3000             | 179.21.084 | £101.00      |
|   |   |                      | 4000             | 179.27.176 | £124.40      |
|   |  | black/silver/black   | 3000             | 179.25.944 | £101.00      |
|   |   |                      | 4000             | 179.23.919 | £124.40      |

## Post & Wall Mounted Accessories

Wall mounted wall clip.



Magnetic wall clip



Belt link for connecting 2 belts.



| Description   | Order Ref  | Price (Each) |
|---|------------|--------------|
| Wall mounted wall clip (1 clip included with cartridge) | 179.16.000 | £9.80        |
| Magnetic wall clip (1 clip included with cartridge)     | 179.26.987 | £17.60       |
| Belt link for connecting 2 belts                        | 179.17.430 | £5.40        |

# TRAFFIC-LINE Impact Protection – Profiles

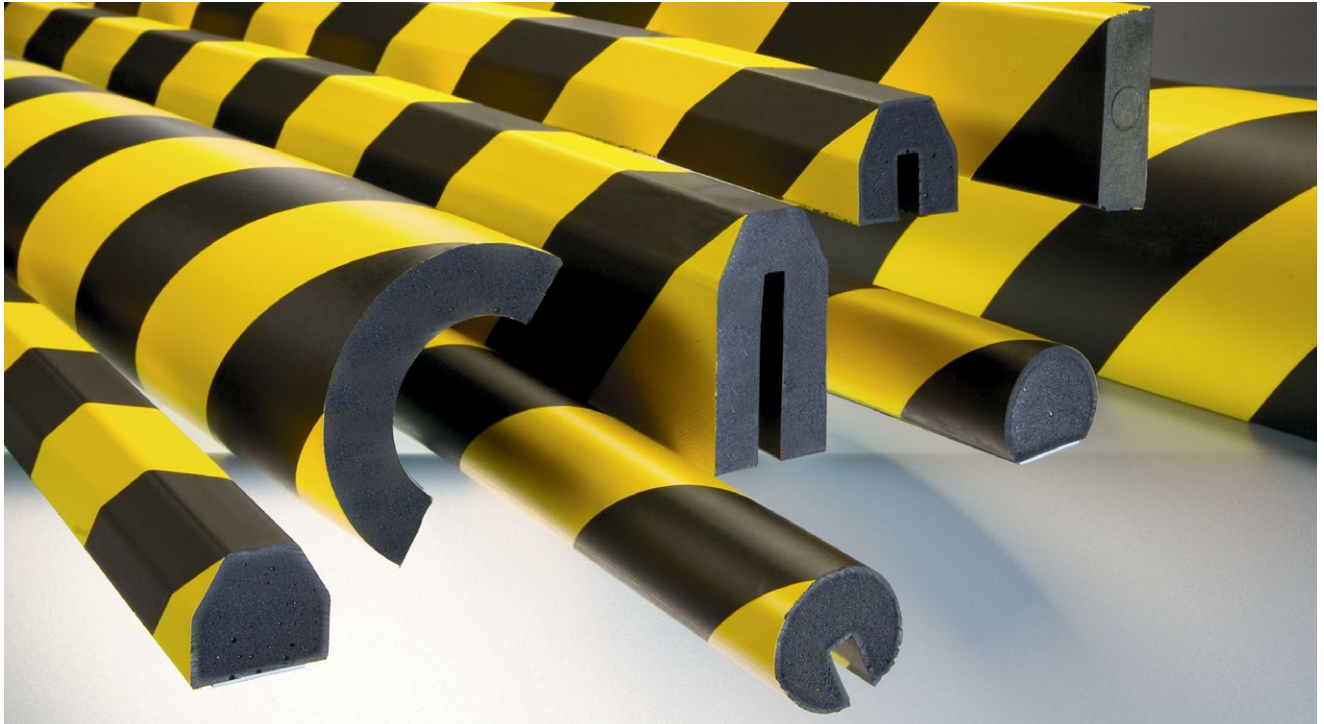

## TRAFFIC-LINE Impact Protection

TRAFFIC-LINE Impact Protection profiles provide both visual warning and safety cushioning to hard unyielding objects.

- Prevents injury and protects property.
- Quick and easy to install.
- High quality moulded sections.
- Standard length is 1,000mm.
- Easily cut to length with sharp knife or fine saw blade.
- Made from flexible age resistant polyurethane foam.
- UV resistant yellow/black colours according to DIN 4844.
- Temperature resistant from -40 °C to + 90°C.
- Fire resistant.
- CFC and silicon free.

## Edge Protection

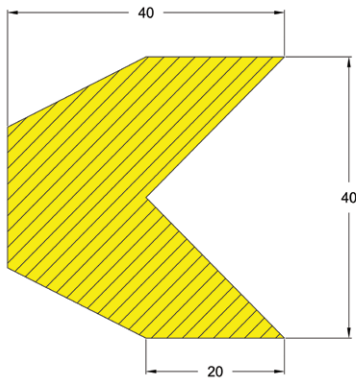

Trapeze 40/40

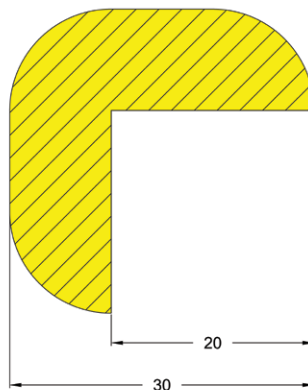

Right-Angle 30/30

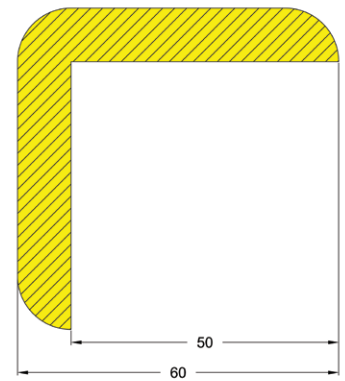

Right Angle 60/60

| Edge Protection     | Colour       | Length (mm)   | Fixing        | Order Ref  | Price (Each) |
|---------------------|--------------|---------------|---------------|------------|--------------|
| Trapeze 40/40       | Yellow/Black | 1000          | Self Adhesive | 422.14.275 | £23.70       |
|                     |              |               | Magnetic      | 422.23.243 | £26.60       |
| Right-Angle 30/30   | Yellow/Black | 1000          | Self Adhesive | 422.17.559 | £23.10       |
|                     |              |               | Magnetic      | 422.24.979 | £26.00       |
|                     | White        |               | Self Adhesive | 422.15.712 | £23.10       |
| Right Angle 60/60   | Yellow/Black | 1000          | Self Adhesive | 422.18.566 | £37.70       |
|                     |              |               | Magnetic      | 422.25.253 | £40.60       |
| Semi-Circular 40/40 | Yellow/Black | 1000          | Self Adhesive | 422.19.099 | £23.70       |
|                     |              |               | Magnetic      | 422.20.276 | £26.60       |
|                     | White        | Self Adhesive | 422.15.039    | £23.70     |              |

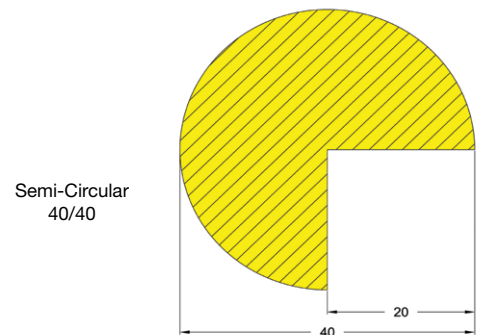

Semi-Circular 40/40



## Surface Protection

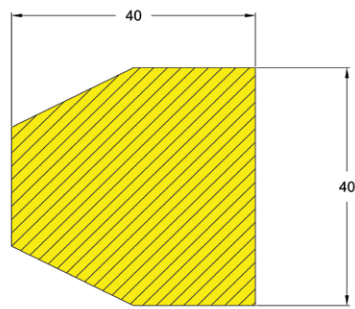

Trapeze 40/40

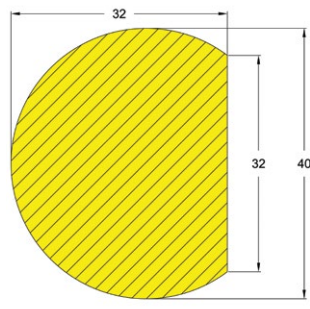

Semi-circular 40/32

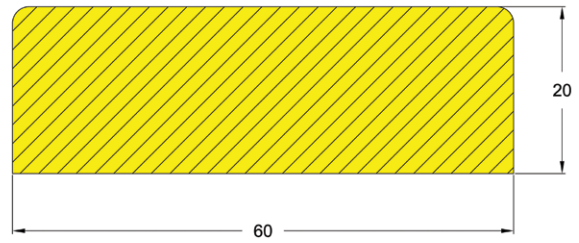

Rectangle 60/20

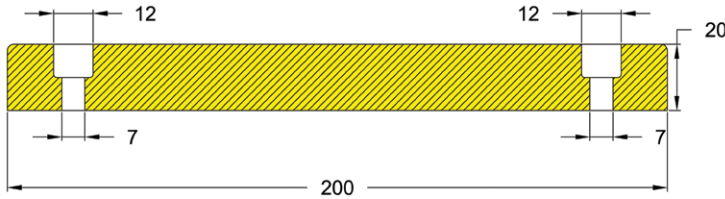

Rectangle 200/20, 4 pre-drilled holes

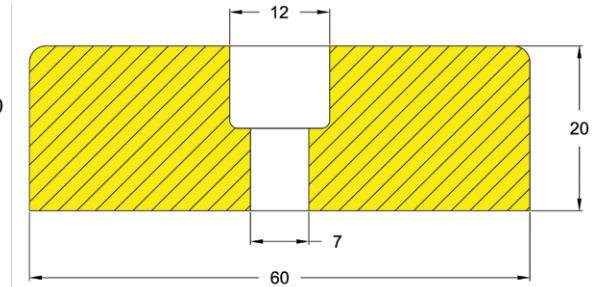

Rectangle 60/20, 3 pre-drilled holes

| Surface Protection                   | Colour       | Length (mm) | Fixing        | Order Ref  | Price (Each) |
|--------------------------------------|--------------|-------------|---------------|------------|--------------|
| Trapeze 40/40                        | Yellow/Black | 1000        | Self Adhesive | 422.18.441 | £22.90       |
|                                      |              |             | Magnetic      | 422.26.582 | £25.80       |
| Semi-circular 40/32                  | Yellow/Black | 1000        | Self Adhesive | 422.13.249 | £22.90       |
|                                      | White        |             | Magnetic      | 422.27.977 | £25.80       |
| Rectangle 60/20                      | Yellow/Black | 1000        | Self Adhesive | 422.18.541 | £22.90       |
|                                      |              |             | Magnetic      | 422.19.912 | £31.10       |
|                                      | White        |             | Self Adhesive | 422.20.678 | £34.00       |
| Rectangle 60/20 3 pre-drilled holes  | Yellow/Black | 1000        | Self Adhesive | 422.18.163 | £31.10       |
| Rectangle 60/20 3 pre-drilled holes  | Yellow/Black | 1000        | Screw/Bolt    | 422.19.509 | £31.10       |
| Rectangle 200/20 4 pre-drilled holes | Yellow/Black | 500         | Screw/Bolt    | 422.15.592 | £60.50       |

## Profile Protection

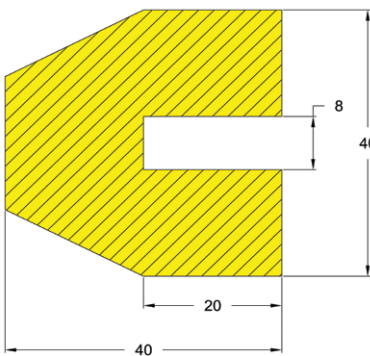

Trapeze 40/40/8

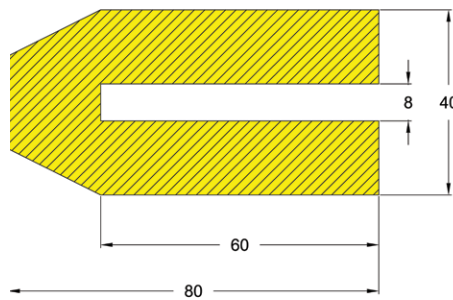

Trapeze 40/80/8

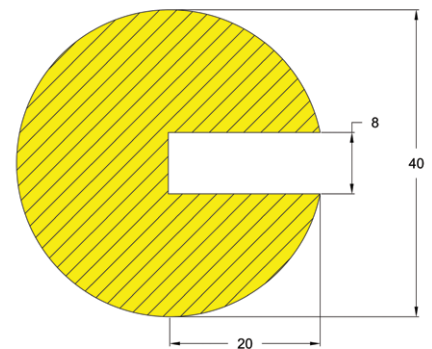

Semi Circular 40/40/8

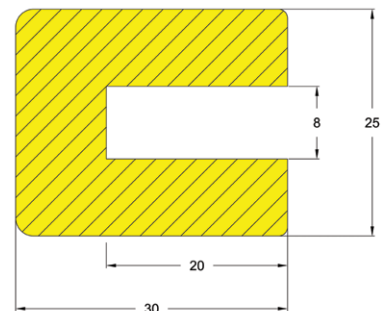

Rectangle 25/30/8

| Profile Protection    | Colour       | Length (mm) | Fixing  | Order Ref  | Price (Each) |
|-----------------------|--------------|-------------|---------|------------|--------------|
| Trapeze 40/40/8       | Yellow/Black | 1000        | Push on | 422.13.264 | £21.80       |
| Trapeze 40/80/8       | Yellow/Black | 1000        | Push on | 422.15.601 | £34.40       |
| Semi Circular 40/40/8 | Yellow/Black | 1000        | Push on | 422.17.696 | £21.80       |
|                       | White        |             |         | 422.18.250 | £21.80       |
| Rectangle 25/30/8     | Yellow/Black | 1000        | Push on | 422.26.168 | £24.10       |

# TRAFFIC-LINE Cable/Hose Protection Ramps

## TRAFFIC-LINE SMALL Cable/Hose Protection Ramps for fast easy deployment.

- Easy and quick deployment.
- Protect cables/hoses up to 40mm Dia.
- High visibility alternating Yellow/Black sections.
- Suitable for HGV and forklift trucks.
- Tough flexible materials.

**Applications:** Emergency services, construction sites, road works, etc

**Material:** Recycled rubber

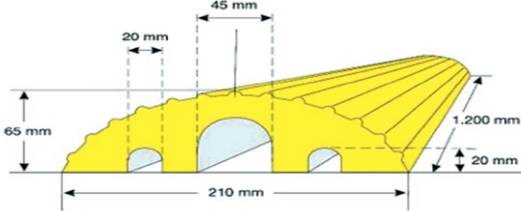

| TRAFFIC-LINE SMALL cable/hose protection ramp                                     |  | Colour | Order Ref  | Price (Each) |
|---|--|--------|------------|--------------|
|  |  | Yellow | 279.28.720 | £56.00       |
|   |  | Black  | 279.21.784 | £56.00       |







## TRAFFIC-LINE LARGE Cable/Hose Protection Ramps – drive over cables, hoses and pipes without causing them damage.

- Easily and quickly deployed.
- Three top loading channels for cables/hoses.
- Anti-slip hinged top panel.
- Interlocking design feature.
- Strong robust construction.
- Suitable for use with HGV's.

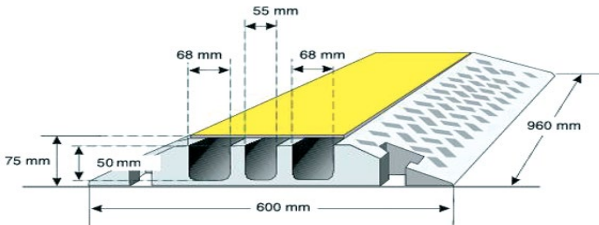
**Applications:** Construction sites, distribution depots emergency works, road works, etc.

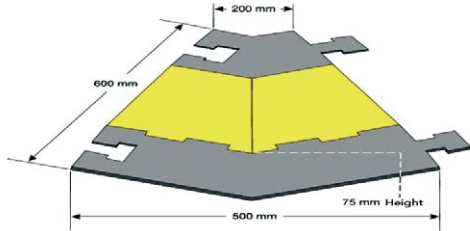
**Material – Body:** Hard rubber.  
**Material Cover:** Polypropylene.

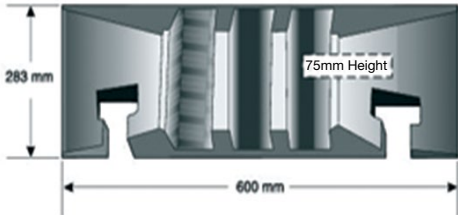

| TRAFFIC-LINE LARGE cable/hose protection ramp   |  | Colour           | Order Ref                  | Price (Each) |
|---|--|------------------|----------------------------|--------------|
|  <p>Centre Section</p> |  | Black/<br>Yellow | 279.23.799                 | £71.30       |
|  <p>Left Hand</p>      |  | Black/<br>Yellow | 279.29.848<br>(Left Hand)  | £35.90       |
|  <p>Right Hand</p>     |  |                  | 279.26.562<br>(Right Hand) | £35.90       |
|                        |  | Black            | 279.20.233                 | £15.80       |
|  <p>End Section</p>    |  |                  | 279.22.899                 | £15.80       |



# TOPSTOP-ECO Speed Reduction Ramps

TOPSTOP-ECO Speed Reduction ramps are the cost effective method of controlling traffic speed. They are supplied in three versions to reduce traffic speeds to 5mph, 10mph and 15mph respectively.

- Easily and quickly installed
- Contrasting colours for daylight visibility.
- Reflectors in 5RE and 10RE for night visibility.
- Cost effective solution
- Sectional construction to suit site conditions.

Material: Recycled materials  
 Colours: Black. Yellow.  
 End sections Yellow only  
 Fixing bolts: 12/100mm Included

**Applications:** Hazardous situations such as exit ways, bends, loading bays, weigh bridges, pedestrian crossings, junctions, schools, manufacturing sites, depots, car parks in hospitals, public houses, hotels, sporting venues and other parking locations etc.

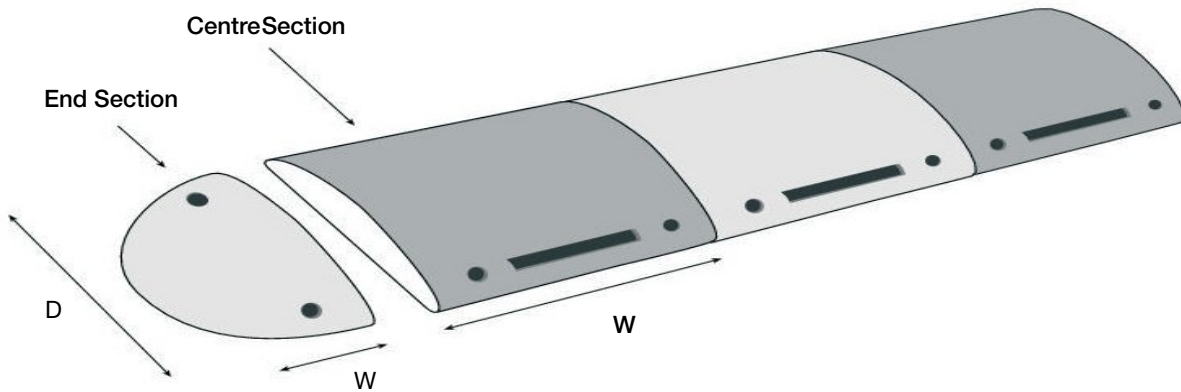

| TOPSTOP-ECO 5RE Recommended speed <5mph                                     | H x W x D (mm) | Colour | Order Ref  | Price (Each)          |
|---|----------------|--------|------------|-----------------------|
| Ramp Section  | 70 x 500 x 500 | Black  | 281.14.155 | £48.40                |
|   |                | Yellow | 281.18.436 | £48.40                |
| End Section - Male  | 70 x 250 x 500 | Yellow | 281.18.224 | £29.00                |
| End Section - Female  |                |        | 281.15.317 | £29.00                |
| It is recommended that appropriate warning signs are used with this product |                |        |            | Fixing Bolts included |

| TOPSTOP-ECO 10RE Recommended speed <10mph                                   | H x W x D (mm) | Colour | Order Ref  | Price (Each)          |
|---|----------------|--------|------------|-----------------------|
| Ramp Section  | 50 x 500 x 400 | Black  | 281.16.415 | £37.60                |
|   |                | Yellow | 281.18.692 | £37.60                |
| End Section - Male  | 50 x 250 x 400 | Yellow | 281.19.480 | £23.20                |
| End Section - Female  |                |        | 281.15.466 | £23.20                |
| It is recommended that appropriate warning signs are used with this product |                |        |            | Fixing Bolts included |

| TOPSTOP-ECO 15RE Recommended speed <15mph                                   | H x W x D (mm) | Colour | Order Ref  | Price (Each)          |
|---|----------------|--------|------------|-----------------------|
| Ramp Section  | 30 x 500 x 500 | Black  | 281.15.289 | £29.40                |
|   |                | Yellow | 281.16.941 | £29.40                |
| End Section   | 30 x 250 x 500 | Yellow | 281.17.266 | £16.80                |
| It is recommended that appropriate warning signs are used with this product |                |        |            | Fixing Bolts included |

# SPION Acrylic Mirrors

The SPION observation mirror is widely accepted as the road side observation mirror among its many other attributes and uses.

- Very light construction.
- Robust, shock resistant.
- Excellent image quality.
- Interior and exterior use.
- Wide angle field of vision.
- Easy installation.
- Ideal for confined spaces.
- Economical Solution.
- Circular or rectangular options.
- Mirror face protected under a tough, clear acrylic layer.
- 5 years guarantee against manufacturing faults.

**Applications:**

Entrances, exits, driveways, manufacturing processes, warehouses, production units, public buildings, hospitals, etc.

**Specifications:**

Circular Sizes: 300, 400, 500, 600, 700 and 800mm Dia.  
 Rectangular Sizes: 400 x 600, 600 x 800 and 800 x 1,000mm

**Material:**

Metalised modified acrylic, under surface coated.

**Bracket:**

25cm 'J' bracket.

**Accessories:**

55cm 'J' bracket.  
 Post fixing clamps.



| Spion observation Mirrors (synthetic glass mirror) |  | Dimension (mm) | Max. obs. Dist. From mirror (m) | Order Ref  | Price (Each) |
|--|--|----------------|---------------------------------|------------|--------------|
|  | With wall mounting J bracket 25cm              | Ø300           | 2                               | 247.17.989 | £56.10       |
|  |  | Ø400           | 3                               | 247.13.962 | £68.10       |
|  |  | Ø500           | 5                               | 247.14.455 | £98.20       |
|  |  | Ø600           | 7                               | 247.19.332 | £117.70      |
|  |  | Ø700           | 9                               | 247.18.522 | £152.10      |
|  |  | Ø800           | 11                              | 247.18.504 | £168.90      |
|  | With brackets for fixing to 60/76 mm Dia posts | 400 x 600      | 5                               | 257.18.638 | £177.50      |
|  |  | 600 x 800      | 8                               | 247.19.825 | £278.50      |
|  |  | 800 x 1000     | 15                              | 247.14.705 | £419.30      |
| 55cm 'J' Bracket                                   |  |                |                                 | 255.10.700 | £18.10       |
| Post fixing kit                                    |  |                |                                 | 247.PCLIP  | £4.80        |



# PANORAMIC 360°, 180° AND 90° Acrylic Mirrors

The PANORAMIC 360°, 180° and 90° Mirror range is an indispensable safety aid to areas that experience high traffic flows.

- Excellent image properties.
- Ultra light weight acrylic material.
- Mirror face protected under a tough, clear acrylic layer.
- Interior use only.
- Can be screwed directly to flat surfaces or suspended by chain set (360° only).
- 360° clear vision for maximum safety.
- Helps to reduce accidents and theft.
- Improves pedestrian traffic flows.
- 5 year guarantee against manufacturing faults.

**Specifications:**

Sizes: 600, 800, 900, 1,000 and 1,250mm (360°).

Sizes: 600, 800, 900, 1,000mm. (180° and 90°)

Material: Metalised acrylic, under surface coated.

Style: 360°, 180° and 90°.

Frame: Frameless.

**Accessories:**

Suspension chain set (360° only).

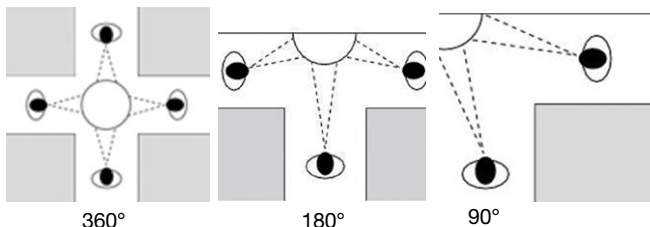

**Applications:** Suitable for use in hospitals, self-service stores, retail outlets, public buildings, manufacturing areas, warehouses, stacker lanes, junctions, indoor car parks etc.

| Panoramic 360° Observation Mirrors   | Diameter of Mirror (mm) | Max. obs. Dist. From mirror (m) | Order Ref  | Price (Each) |         |
|--|-------------------------|---------------------------------|------------|--------------|---------|
|  | 360/600                 | 600                             | 3          | 250.15.138   | £124.40 |
|  | 360/800                 | 800                             | 4          | 250.17.220   | £131.30 |
|  | 360/900                 | 900                             | 5          | 250.10.202   | £152.90 |
|  | 360/1000                | 1000                            | 6          | 250.18.256   | £205.10 |
|  | 360/1250                | 1250                            | 8          | 250.13.084   | £311.10 |
| Panoramic 360° Accessories   |                         | Application                     | Order Ref  | Price (Each) |         |
| Chain set (Chain length 4m)  |                         | For suspended fitting           | 255.10.618 | £8.80        |         |

| Panoramic 180° Observation Mirrors  | Mirror size (mm)   | Max. obs. Dist. From mirror (m) | Order Ref | Price (Each) |         |
|---|--------------------|---------------------------------|-----------|--------------|---------|
|  | Panoramic 180/600  | 600 x 320 x 240                 | 5         | 256.17.911   | £60.20  |
|   | Panoramic 180/800  | 800 x 410 x 330                 | 6         | 256.14.205   | £70.60  |
|   | Panoramic 180/900  | 900 x 450 x 250                 | 7         | 250.16.959   | £97.20  |
|   | Panoramic 180/1000 | 1000 x 530 x 400                | 8         | 256.17.882   | £111.80 |

| Panoramic 90° Observation Mirrors   | Mirror size (mm)  | Max. obs. Dist. From mirror (m) | Order Ref | Price (Each) |        |
|---|-------------------|---------------------------------|-----------|--------------|--------|
|  | Panoramic 90/600  | 300 x 300 x 240                 | 5         | 257.17.652   | £30.80 |
|   | Panoramic 90/800  | 400 x 400 x 330                 | 6         | 257.17.048   | £35.50 |
|   | Panoramic 90/900  | 420 x 420 x 360                 | 7         | 250.13.342   | £40.70 |
|   | Panoramic 90/1000 | 490 x 490 x 400                 | 8         | 257.16.835   | £61.00 |

# DETECTIVE-X Acrylic Convex Mirrors

The **DETECTIVE-X Convex Mirror** is a lightweight interior observation and control mirror ideally suited for areas where people circulate, affording observation where medium to large fields of vision are required.

- Outstanding image quality.
- Helps to prevent accidents and theft.
- Ultra lightweight acrylic material.
- Eliminates risks associated with glass mirrors.
- Mirror face protected under a tough, clear acrylic layer.
- Interior use only.
- Extremely shock-resistant construction.
- 5 year guarantee against manufacturing faults.

**Specification:**

Diameters: 300, 400, 500 600, 700 and 800mm.  
 Material: Metalised acrylic, under surface coated.  
 Bracket: 25cm 'J' bracket.

**Accessories:**

55cm 'J' bracket.  
 Post fixing clamps.

**Applications:** The DETECTIVE-X is used in self-service stores, retail outlets, public buildings, warehouses, manufacturing areas etc.



| Acrylic glass mirror (complete with j bracket 25cm)   | Diameter Mirror (mm) | Max. obs. Dist. From mirror (mm) | Order Ref  | Price (Each) |
|---|----------------------|----------------------------------|------------|--------------|
|  <p>With normal wall mounting 25cm</p> | 300                  | 2                                | 251.13.487 | £46.10       |
|   | 400                  | 3                                | 251.17.667 | £54.00       |
|   | 500                  | 5                                | 251.18.945 | £80.20       |
|   | 600                  | 7                                | 251.15.534 | £99.20       |
|   | 700                  | 9                                | 251.16.210 | £126.80      |
|   | 800                  | 11                               | 251.13.505 | £137.20      |
| 55cm 'J' Bracket  |                      |                                  | 255.10.700 | £18.10       |
| Post fixing kit   |                      |                                  | 257.Pclip  | £4.80        |



# TRAFFIC-LINE Bicycle Racks

## TRAFFIC-LINE Compact Bicycle Rack

Versions for 3, 4 or 5 bicycles. An economical medium duty bicycle rack.

- Zinc plated steel construction.
- Fully assembled.
- Suitable for bicycles up to tyre width 50mm.
- Accessible from both sides.
- Great value for money.
- Supplied with fixings.

**Applications:**

Domestic, company bicycle parks, small housing estates, schools etc.

**Specification:**

Frame: Steel

**Sizes:**

3 Bicycle Capacity - 255 H x 385 D x 730mm W  
 4 Bicycle Capacity - 255 H x 385 D x 1180mm W  
 5 Bicycle Capacity - 255 H x 385 D x 1340mm W  
 16mm Ø tube wheel supports.



| TRAFFIC-LINE Bicycle Racks for up to 3, 4 and 5 bicycles (H) 255mm x (D) 385mm     | Bicycle capacity | Overall width (mm) | Order Ref  | Price (Each) |
|--|------------------|--------------------|------------|--------------|
|  | 3                | 720                | 169.28.632 | £44.10       |
|  | 4                | 1180               | 169.15.334 | £54.50       |
|  | 5                | 1340               | 169.19.382 | £64.70       |

## TRAFFIC-LINE Wall Mounted Bicycle Rack

Individual bicycle rack units.

- Adjustable through 180 degrees.
- Wall mounting – easily secured.
- Compact and flexible design.
- Zinc plated steel construction.
- Suitable for bicycles up to tyre width 50mm.
- Supplied with wall fixings.
- Fully assembled.

**Applications:**

Domestic, company bicycle parks, public spaces, public & commercial buildings, schools etc.

**Specification:**

Frame: Steel

**Size:**

335 H x 285 D x 90mm W  
 16mm Ø tube wheel supports.



| TRAFFIC-LINE Wall mounted bicycle rack  | Bicycle capacity | Overall width (mm) | Order Ref  | Price (Each) |
|---|------------------|--------------------|------------|--------------|
|  | 1                | 90                 | 169.17.113 | £18.80       |



# Kenilworth



The Kenilworth is an attractive, curved cycle shelter, popular with schools and colleges and offers floor to roof level protection from the prevailing elements.

This is a tough, robust structure with vandal resistant features.

- Zinc coated with powder coated finish in any RAL colour - also available fully galvanised.
- Leg frame can either be bolted to the floor or grouted into the ground. Ground fixing option supplied as standard.
- Designed for use with our Sheffield and Harrogate loops and racks. Please call our sales team for details.
- Initial shelters can be linked side by side to form longer runs.
- The Kenilworth is also available as a cycle compound, with or without security gates and has a no crawl under perimeter for added security.
- Parabolts for surface mounting included. Must be bolted to 250mm thick concrete pad for stability.

## Kenilworth Cycle Shelter

| H x D (mm)  | Width (mm) | Order Ref  |               | Price (Each) |
|-------------|------------|------------|---------------|--------------|
|             |            | Galvanized | Powder Coated |              |
| 2230 x 2150 | 2000       | SCKN2020OV | SCKN2020OJ    | £1837.50     |
| 2230 x 2150 | 3000       | SCKN3020OV | SCKN3020OJ    | £2012.50     |
| 2230 x 2150 | 4000       | SCKN4020OV | SCKN4020OJ    | £2187.50     |
| 2230 x 2150 | 5000       | SCKN5020OV | SCKN5020OJ    | £2362.50     |

If sited within 5 miles of the coast, we strongly recommend that the shelters and racks are galvanised.

Our most popular colours are:

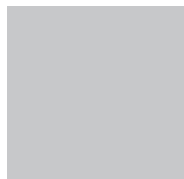

RAL 9006  
Silver

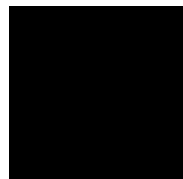

RAL 9005  
Jet Black



RAL 9024  
Pine Green



RAL 5017  
Traffic Blue



## Premier Cycle Shelters

The Premier Cycle Shelter has a more curved, contemporary design intended to blend into both traditional and modern environments, thus providing tidy and secure storage of cycles on any site.



### Framework Colour Options



- Choice of clear Perspex or Powder coated steel side and back panels.
- Adjustable feet for on-site positioning.
- Parabolts for surface mounting included. Must be bolted to 250mm thick concrete pad for stability.
- Site survey and installation service available.
- Comes complete with integrated twin-level bike rack for eight bikes - Hoop Racks are also available on request.

\*Insert (L) for Light Grey, (G) for Pine Green or (B) for Traffic Blue. Other colours available at extra cost, speak to sales for details.

If sited within 5 miles of the coast, we strongly recommend that the shelters and racks are galvanized.

### Premier Shelter

| H x W x D (mm)     | Side Panels   | Order Ref    | Price (Each) |
|--------------------|---------------|--------------|--------------|
| 2320 x 3000 x 2100 | Perforated    | SC223021P*XX | £2436.00     |
| 2320 x 3000 x 2100 | Clear Perspex | SC223021X*XX | £2705.92     |

### Premier Shelter - Extension

| H x W x D (mm)     | Side Panels   | Order Ref    | Price (Each) |
|--------------------|---------------|--------------|--------------|
| 2320 x 3000 x 2100 | Perforated    | SC223021P*EA | £2260.16     |
| 2320 x 3000 x 2100 | Clear Perspex | SC223021X*EA | £2465.12     |

# PROline-tape Floor Marking System

## Self-adhesive floor marking tape

PROline-tape is an extremely tough floor marking tape for quick and effective marking of internal surfaces. Aisles, traffic ways and other demarcation areas can be identified precisely, cleanly and economically.

- Available in 50mm and 75mm widths x 33m long.
- Six bold safety colours.
- Three diagonally striped hazard warning colours.
- Striped tapes are laminated to protect print surface.
- Leaves no residue when removed from most surfaces.
- Ideal for short and medium term marking.

### Specification:

Widths: 50 and 75mm  
 Thickness: Plain: 0.15mm Laminated: 0.18mm  
 Length: 33m  
 Core: 75mm ID  
 Colours: 6 plain  
 3 Diagonal striped

PROline-tape is easily and quickly applied with the TAPEliner applicator, and is particularly useful where extensive marking is required.

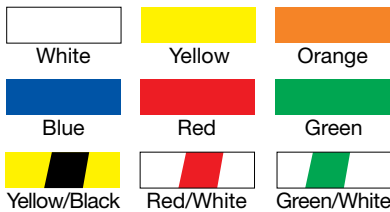

Also available is our PROline Marker Kit which contains all of the elements required to get started. When ordering please specify colour(s) and width of tape required.

The TAPEliner Applicator Kit consists of:

- 1 x TAPEliner Applicator
  - 2 x Rolls of PROline tape
  - 1 x Trimming knife
  - 1 x Marker line and chalk
- Individual rolls are available.



| Indication            | Colour                |
|-----------------------|-----------------------|
| General marking       | White                 |
| Hazard/caution        | Yellow & Yellow/Black |
| Danger/prohibition    | Red                   |
| Mandatory protection  | Blue                  |
| Information/direction | Green & Green/White   |
| Chemical storage      | Orange                |
| Fire equipment        | Red/White             |

| 33m Long - Tape width 50mm and 70mm | Colour                   | 50mm Tape   |              | 70mm Tape  |              |
|-------------------------------------|--------------------------|-------------|--------------|------------|--------------|
|                                     |                          | Order Ref   | Price (Each) | Order Ref  | Price (Each) |
|                                     | White                    | 261.16.606  | £3.80        | 261.16.619 | £5.70        |
|                                     | Yellow                   | 261.13.796  | £3.80        | 261.18.798 | £5.70        |
|                                     | Blue                     | 261.19.771  | £3.80        | 261.15.989 | £5.70        |
|                                     | Red                      | 261.13.752  | £3.80        | 261.18.675 | £5.70        |
|                                     | Green                    | 261.189.249 | £3.80        | 261.16.655 | £5.70        |
|                                     | Orange                   | 261.16.322  | £3.80        | 261.17.531 | £5.70        |
|                                     | Red/White (laminated)    | 261.18.826  | £5.90        | 261.15.954 | £8.80        |
|                                     | Yellow/Black (laminated) | 261.17.941  | £5.90        | 261.13.438 | £8.80        |
|                                     | Green/White (laminated)  | 261.17.310  | £5.90        | 261.19.066 | £8.80        |

| PROline-tape Floor Marking System | Description  | Tape Colour   | Order Ref  | Price (Each) |         |
|-----------------------------------|--|---|------------|--------------|---------|
|                                   | PROline Tape Marking Set (Inc. 50mmx33mTape)<br>TAPEliner<br>2 Rolls of PROline Tape<br>1 Trimming Knife Marker Line & Chalk | White   | 261.15.202 | £152.70      |         |
|                                   |  | Yellow  | 261.17.297 | £152.70      |         |
|                                   |  | Blue  | 261.14.977 | £152.70      |         |
|                                   |  | Red   | 261.15.660 | £152.70      |         |
|                                   |  | Green   | 261.19.541 | £152.70      |         |
|                                   |  | Orange  | 261.17.130 | £152.70      |         |
|                                   |  | PROline Tape Marking Set (Inc. 70mm x 33m Tape)<br>TAPEliner<br>2 Rolls of PROline Tape<br>1 Trimming Knife Marker Line & Chalk | White      | 261.19.212   | £157.20 |
|                                   | Yellow   |   | 261.18.900 | £157.20      |         |
|                                   | Blue   |   | 261.16.487 | £157.20      |         |
|                                   | Red  |   | 261.16.560 | £157.20      |         |
|                                   | Green  |   | 261.17.656 | £157.20      |         |
|                                   | Orange   |   | 261.13.748 | £157.20      |         |
|                                   | TAPEliner: Marker with Trimming knife  |   |            | 261.16.528   | £131.20 |



# PROline-paint Marking System

PROline-paint is developed for rapid and effortless marking of indoor and outdoor areas.

- Long lasting, durable and cost-effective.
- Easy to use – shake can, insert into applicator and apply.
- Markings are highly visible and are abrasion and chemical resistant.
- Adheres to most surfaces – concrete, asphalt, tarmac, metal, tiles etc.
- Fast drying normally within minutes.
- Economical – one 750ml can will produce 50mm wide line 50-90 meters long (Dependant on surface).
- Environmentally friendly - conforms to latest EU regulations.

**Specification:**

Paint: Synthetic resin.  
 Colours: 8 safety colours.  
 Container: 750ml Aerosol can  
 Propellant: Butane

**Applicators:**

**PROliner:**

- Minimal assembly.
- Uses one 750ml can of PROline-paint.
- Easy and rapid line marking – up to 25 meters per minute.

- Quick adjustment between 50 and 75mm.
- Rear wheels easily removed to allow for marking close to walls, machinery, shelves etc.
- Colours can be changed without needing to clean the machine.

**ROADliner:**

Enjoys all of the benefits above but creates line widths between 100 and 130mm using two cans of PROline-paint.

**HANDliner:**

Specially designed for use in hand marking, use with stencils and to highlight objects, obstructions, steps etc. Use with a single can of PROline-paint.

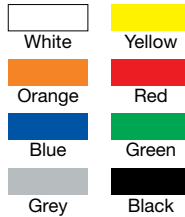

| PROline-paint Marking System   | Description  | Order Ref  | Price (Each) |
|--|--|------------|--------------|
|  | PROline Paint Marking Set WHITE<br>1 PROliner Applicator 50mm to 75mm lines<br>2 Cans of PROline Paint<br>1 PROline Marker Line & Chalk  | 260.11.610 | £138.00      |
|  | PROline Paint Marking Set YELLOW<br>1 PROliner Applicator 50mm to 75mm lines<br>2 Cans of PROline Paint<br>1 PROline Marker Line & Chalk | 260.11.795 | £138.00      |

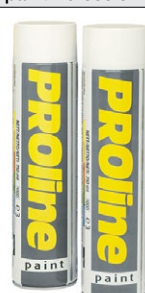
| PROline-paint Aerosols  | Description | Order Ref  | Price (Each) |
|---|-------------|------------|--------------|
|  | White       | 260.11.745 | £10.60       |
|   | Yellow      | 260.11.089 | £10.60       |
|   | Orange      | 260.17.886 | £10.60       |
|   | Red         | 260.12.976 | £10.60       |
|   | Green       | 260.11.015 | £10.60       |
|   | Blue        | 260.12.531 | £10.60       |
|   | Grey        | 260.11.057 | £10.60       |
|   | Black       | 260.11.954 | £10.60       |

| PROline-paint Applications  | Description                             | Order Ref  | Price (Each) |
|---|---|------------|--------------|
|  | PROliner Applicator for 50mm to 75mm    | 260.10.174 | £100.10      |
|   | ROADliner Applicator for 100mm to 130mm | 260.10.383 | £139.10      |
|   | HANDliner Applicator for hand use       | 260.10.437 | £27.10       |

| PROline-paint Stencil Sets  | Description                           | Order Ref  | Price (Each) |
|---|---------------------------------------|------------|--------------|
|  | 15cm Stencils for Letters and Symbols | 260.10.503 | £151.20      |
|   | 30cm Stencils for Letters and Symbols | 260.11.149 | £200.70      |

# Labels and Markers

## Self Adhesive Vinyl Labelling

- Easily applied peel-off labels
- Cleanly removed
- Black characters on yellow background
- For factories, warehouses and storerooms
- Supplied on cards in identical characters



Shown not to scale

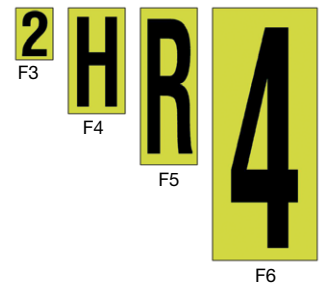

| Cards of Individual Characters (0-9 or A-Z) |                     |           |                |
|---|---------------------|-----------|----------------|
| Label Size H x W (mm)                       | Characters Per Card | Order Ref | Price Per Card |
| 19 x 14                                     | 36                  | F3        | £0.96          |
| 38 x 21                                     | 12                  | F4        | £0.96          |
| 56 x 21                                     | 12                  | F5        | £1.35          |
| 90 x 38                                     | 6                   | F6        | £1.86          |
| 130 x 45                                    | 5                   | F7        | £2.40          |
| 230 x 140                                   | 1                   | F8        | £2.40          |

| Complete Letter & Number Sets |                     |               |               |        |        |
|-------------------------------|---------------------|---------------|---------------|--------|--------|
| Label Size H x W (mm)         | Characters Per Card | 0-9 Set of 10 | A-Z Set of 26 |        |        |
| 19 x 14                       | 36                  | F3/0-9        | £9.60         | F3/A-Z | £24.96 |
| 38 x 21                       | 12                  | F4/0-9        | £9.60         | F4/A-Z | £24.96 |
| 56 x 21                       | 12                  | F5/0-9        | £13.50        | F5/A-Z | £35.10 |
| 90 x 38                       | 6                   | F6/0-9        | £18.60        | F6/A-Z | £48.36 |
| 130 x 45                      | 5                   | F7/0-9        | £24.00        | F7/A-Z | £62.40 |
| 230 x 140                     | 1                   | F8/0-9        | £24.00        | F8/A-Z | £62.40 |

## Magnetic & Self Adhesive Aisle Markers

High Visibility aisle markers provide instant identification for all areas, saving time and reducing costs.

- High visibility white or yellow styrene
- Flat types are corner drilled for easy fixing
- Flange signs are designed for right angled display, and may be lettered both sides if required
- We letter the signs for you, so quote your exact requirements
- Other sizes available



| Aisle Marker Signs Complete With Digits |            |                   |           |              |
|---|------------|-------------------|-----------|--------------|
| Style                                   | H x W (mm) | Digits Provided   | Order Ref | Price (Each) |
| Flat, Drilled Corners                   | 95 x 160   | Up to 3 (50mm)    | AM1       | £6.45        |
| Self Adhesive Flanged                   | 95 x 130   | Up to 3 Each Side | AM1F      | £6.96        |
| Magnetic Flanged                        | 95 x 130   |                   | AM1FM     | £7.35        |
| Self Adhesive Flanged                   | 95 x 130   |                   | AM1T      | £10.95       |
| Magnetic Flanged                        | x 130      |                   | AM1TM     | £12.60       |
| Flat, Drilled Corners                   | 220 x 270  | 1 (180mm)         | AM2/1     | £9.18        |
| Flat, Drilled Corners                   | 220 x 270  | 2 (180mm)         | AM2/2     | £12.60       |
| Flat, Drilled Corners                   | 220 x 450  | 1 (180mm)         | AM3/1     | £9.81        |
| Flat, Drilled Corners                   | 220 x 450  | 2 (180mm)         | AM3/2     | £13.80       |
| Flat, Drilled Corners                   | 220 x 450  | 3 (180mm)         | AM3/3     | £17.25       |
| Flat, Drilled Corners                   | 560 x 343  | 1 x 500           | AM4       | £18.45       |
| Flat, Drilled Corners                   | 600 x 600  | 1 x 450           | AM6/1     | £45.30       |

## Magnetic & Self Adhesive Bay Markers

High Visibility bay markers for clear identification in the warehouse.

- Aluminium Marker
- Fixed within seconds - no drilling required
- Supplied blank - add your own lettering from our F-8 range
- Sizes for single and double digit signs
- Confirm character(s) required when ordering

| Description              | H x W (mm) | Max Digits | Order Ref | Price (Each) |
|--------------------------|------------|------------|-----------|--------------|
| Magnetic Edge Sign       | 260 x 167  | 1          | BM1       | £16.20       |
| Magnetic Edge Sign       | 260 x 310  | 2          | BM2       | £23.10       |
| Self Adhesive Edge Sign  | 260 x 167  | 1          | BA1       | £16.20       |
| Self Adhesive Edge Sign  | 260 x 310  | 2          | BA2       | £23.10       |
| S/Vinyl Letter or Number | 230 x 140  | -          | F-8       | £2.40        |

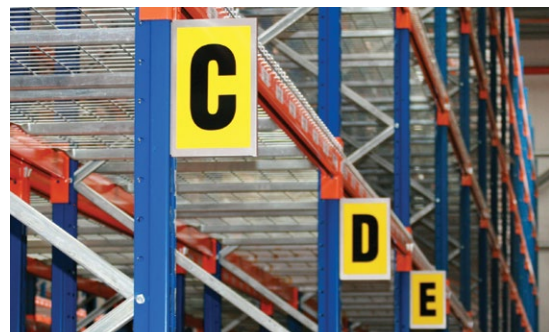



# Self Adhesive & Magnetic Holders

## Label Holders

- Instant identification for steel racking and shelving
- Individual pre-cut labels, or cut your own size off the roll or strip
- Magnetic or Self Adhesive fixing with protective transparent PVC strip included
- White card supplied as standard



| Self Adhesive Label Holders (White) |           |           |              |
|-------------------------------------|-----------|-----------|--------------|
| H x W (mm)                          | Quantity  | Order Ref | Price (Each) |
| 15 x 80                             | 100       | AL18      | £38.40       |
| 30 x 80                             | 100       | AL38      | £52.20       |
| 50 x 80                             | 100       | AL58      | £64.50       |
| 15 x 1000                           | 10 Strips | AL1/10    | £30.00       |
| 30 x 1000                           | 10 Strips | AL3/10    | £40.80       |
| 50 x 1000                           | 10 Strips | AL5/10    | £47.70       |

| Magnetic Label Holders (Brown) |          |           |              |
|--------------------------------|----------|-----------|--------------|
| H x W (mm)                     | Quantity | Order Ref | Price (Each) |
| 15 x 80                        | 100      | ML18      | £31.35       |
| 20 x 80                        | 100      | ML28X     | £35.70       |
| 25 x 80                        | 100      | ML28      | £38.70       |
| 30 x 80                        | 100      | ML38      | £42.90       |
| 40 x 80                        | 100      | ML48      | £56.70       |
| 50 x 80                        | 100      | ML58      | £69.90       |
| 60 x 100                       | 100      | ML610     | £80.70       |
| 40 x 5000                      | 1 Roll   | MLR4/5    | £34.80       |
| 40 x 1000                      | 1 Roll   | MLR4/10   | £69.30       |

## Ticket Holders

- Clear plastic ticket holders
- Front pulls forward for card to be inserted
- White card is included with all ticket holders
- Quick and easy to update
- Magnetic or self adhesive backing



| H x W (mm) | Quantity | Magnetic  |        | Self Adhesive |        |
|------------|----------|-----------|--------|---------------|--------|
|            |          | Order Ref | Price  | Order Ref     | Price  |
| 25 x 100   | 100      | TS210M    | £69.60 | TS210         | £39.60 |
| 25 x 200   | 50       | TS220M    | £55.20 | TS220         | £37.80 |
| 25 x 1000  | 10       | TS25/10M  | £48.30 | TS25/10       | £30.90 |
| 38 x 100   | 100      | TS310M    | £73.50 | TS310         | £42.90 |
| 38 x 200   | 50       | TS320M    | £59.10 | TS320         | £40.50 |
| 38 x 1000  | 10       | TS38/10M  | £54.30 | TS38/10       | £35.70 |
| 54 x 100   | 100      | TS510M    | £87.30 | TS510         | £59.40 |
| 54 x 200   | 50       | TS520M    | £78.60 | TS520         | £53.70 |
| 54 x 1000  | 10       | TS54/10M  | £76.50 | TS54/10       | £51.30 |
| 80 x 100   | 100      | TS810M    | £94.20 | TS810         | £64.50 |
| 80 x 200   | 50       | TS820M    | £85.80 | TS820         | £60.00 |
| 80 x 1000  | 10       | TS80/10M  | £80.40 | TS80/10       | £56.10 |

## Easy Wipe Magnetic Strip

- Locates on to any steel surface
- Cut to any length to suit

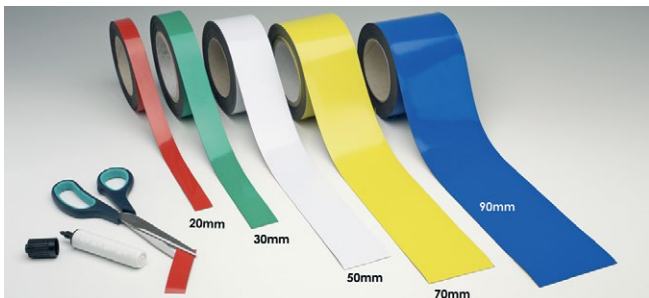

- Write on, wipe off
- Blue, Yellow, White, Green & Red

| Magnetic Easy Wipe Racking Strip |           |        |             |           |        |
|----------------------------------|-----------|--------|-------------|-----------|--------|
| W x L (mm)                       | Order Ref | Price  | Roll Size   | Order Ref | Price  |
| 10 x 10000                       | MSR1      | £12.60 | 50 x 10000  | MSR5      | £44.70 |
| 15 x 10000                       | MSR15     | £17.85 | 60 x 10000  | MSR6      | £45.00 |
| 20 x 10000                       | MSR2      | £21.45 | 70 x 10000  | MSR7      | £52.20 |
| 25 x 10000                       | MSR25     | £25.80 | 80 x 10000  | MSR8      | £56.10 |
| 30 x 10000                       | MSR3      | £29.10 | 90 x 10000  | MSR9      | £60.30 |
| 40 x 10000                       | MSR4      | £37.20 | 100 x 10000 | MSR10     | £65.40 |

## Self Adhesive Magnetic Strip

- Locates on any steel surface
- Makes anything magnetic
- Eliminates the need for drilling
- Strong Permanent Self Adhesive on one side, Magnetic on the other

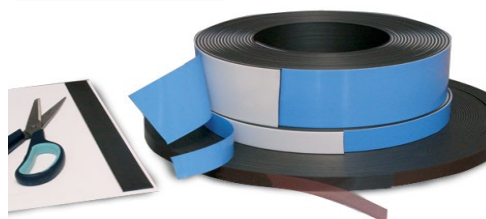

| Self Adhesive Magnetic Strip |           |        |
|------------------------------|-----------|--------|
| W x L (mm)                   | Order Ref | Price  |
| 13 x 30000                   | MSSA/13   | £64.80 |
| 20 x 10000                   | MSSA/20   | £34.50 |
| 50 x 10000                   | MSSA/50   | £53.70 |

# Identification And Labelling

## Magnetic & Self Adhesive Ticket Pouches

- Information pockets manufactured in tough PVC
- Available in magnetic or self adhesive & printed black on yellow or white background. Please state colour and text required
- The label can be easily inserted behind the transparent cover holding the label firmly in place



| Document Size<br>H x W (mm) | Pack<br>(Qty) | Self Adhesive |              | Magnetic  |              |
|-----------------------------|---------------|---------------|--------------|-----------|--------------|
|                             |               | Order Ref     | Price (Pack) | Order Ref | Price (Pack) |
| 30 x 100                    | 100           | SAP310        | £54.60       | MP310     | £60.60       |
| 40 x 120                    | 100           | SAP412        | £57.60       | MP412     | £72.30       |
| 60 x 100                    | 100           | SAP610        | £60.30       | MP610     | £84.00       |
| 60 x 140                    | 100           | SAP614        | £67.50       | MP614     | £96.30       |

## Document Pockets

- Self Adhesive pockets have an aggressive tape on the reverse for permanent fixing
- Magnetic pockets for steel cabinets or racking & shelving
- Manufactured in tough clear polypropylene with welded edges, providing ample room for A4, A5 & A7 documents
- Pockets supplied in packs of 10 except A7 size which is supplied in packs of 100

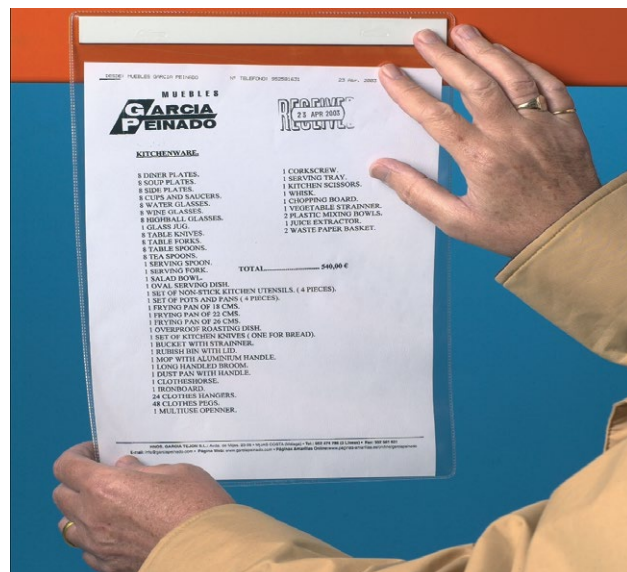

| Size<br>H x W (mm) | Self Adhesive |              | Magnetic  |              |
|--------------------|---------------|--------------|-----------|--------------|
|                    | Order Ref     | Price (Pack) | Order Ref | Price (Pack) |
| 215 x 310 (A4)     | AP4H/10       | £17.85       | MP4H/10   | £26.10       |
| 310 x 220 (A4)     | AP4V/10       | £17.85       | MP4V/10   | £26.10       |
| 155 x 230 (A5)     | AP5H/10       | £15.00       | MP5H/10   | £21.45       |
| 215 x 160 (A5)     | AP5V/10       | £15.00       | MP5V/10   | £21.45       |
| 60 x 110 (A7)      | AP7H/100      | £54.30       | MP7H/100  | £72.00       |

## Warehouse Information Labels

- High Visibility individual weight loading labels suitable for both racking and shelving
- Available in magnetic or self adhesive & printed black on yellow or white background. Please state colour and text required



| Document Size<br>H x W (mm) | Self Adhesive |              | Magnetic  |              |
|-----------------------------|---------------|--------------|-----------|--------------|
|                             | Order Ref     | Price (Each) | Order Ref | Price (Each) |
| 25 x 200                    | BL23          | £0.90        | BL23M     | £1.47        |
| 50 x 300                    | BL53          | £1.44        | BL53M     | £2.79        |
| 70 x 300                    | *BL73         | £2.10        | *BL73M    | £3.72        |
| 90 x 300                    | *BL93         | £2.52        | *BL93M    | £4.65        |

\* Print may appear on two lines

## Beam & Shelf Location Code Labelling

- High quality custom made location code labels produced quickly and efficiently
- They can incorporate alpha-numeric codes, directional arrows, check digits & barcodes
- Black text on white or yellow background
- Installation service available - Call for details





# Floor Signals, Graphic Markers and Racksacks

## Floor Signals

- Highlight walkways, fork truck routes and pallet positions on the warehouse floor
- Tough PVC with aggressive adhesive backing
- Mark block stack pallet areas quickly and effectively with no mess
- Designed to withstand everyday warehouse traffic
- Suitable for clean, flat, sealed surfaces
- Packs available in Yellow, Red, Blue, Green, Black and White

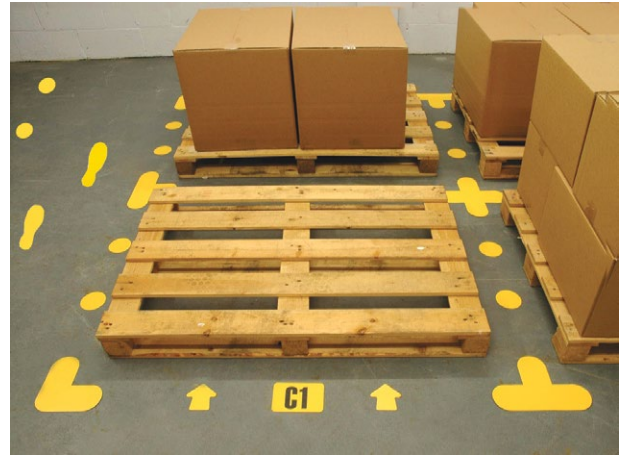

| Signal Shape | Size (mm) | Pack (Qty) | Order Ref | Price (Pack) |
|--------------|-----------|------------|-----------|--------------|
| Cross        | 300 x 300 | 10         | FS/+      | £19.80       |
| T            | 200 x 300 | 10         | FS/T      | £13.50       |
| L            | 200 x 200 | 10         | FS-L      | £13.50       |
| Circle       | 90 dia    | 100        | FS/O      | £31.35       |
| Arrow        | 90 High   | 100        | FS/A      | £31.35       |
| Feet         | 300 x 100 | 10         | SF/F      | £13.50       |

## Floor Graphic Markers

High visibility floor graphics to highlight warnings and operational hazards.

- Permanent adhesive
- Graphics printed on the underside of a clear PVC film
- Signs withstand everyday warehouse traffic

| Size (mm)      | Order Ref | Price (Each) |
|----------------|-----------|--------------|
| 430mm diameter | FM 01-22  | £17.85       |



## Racksacks

- Manage your warehouse waste
- To be mounted onto 900/1100 Racking End Frames
- Quick & Easy S hook locator fixings (supplied)
- Manufactured from tough woven polyester
- Choice of 14 standard designs & specials are available (Call for details)

| Overall Size (mm) | Single Unit |              | Pack of 5 |              | Pack of 10 |              |
|-------------------|-------------|--------------|-----------|--------------|------------|--------------|
|                   | Order Ref   | Price (Pack) | Order Ref | Price (Pack) | Order Ref  | Price (Pack) |
| 1000 x 920        | RSB/1       | £19.80       | RSB/5     | £92.70       | RSB/10     | £173.70      |



## Packaging Products

### Vinyl Hazard Tape

- Made from heavy duty vinyl film with rubber adhesive
- Tear resistant and will stick to most clean surfaces
- Ideal for highlighting dangerous or quarantined areas
- Available in either Yellow/Black or Red/White warning stripes
- Each roll 50mm width x 3300 mm
- Supplied in a pack consisting of 18 rolls per colour



| Description              | W x L (mm) | Order Ref   | Price (Per Pack) |
|--------------------------|------------|-------------|------------------|
| Yellow/Black Hazard Tape | 50 x 3300  | 012477YB/18 | £160.00          |
| Red/white Hazard Tape    | 50 x 3300  | 012477RW/18 | £160.00          |

### Cargo Box

- Made from high strength Double Wall corrugated material
- Will hold up to 30 kg when erected
- Easy fold up erection. Requires no taping
- Has 3 layers of double wall corrugated on base when assembled
- Features Handholds on sides as well as ends
- Has pictogram feature for easy identification of contents
- Flat top allows for easy and safe stacking
- Ideal for removals, storage or archiving
- Available in two sizes, 400 x 320 x 320mm or 660 x 350 x 360mm
- Supplied in packs of 20 per size



| Description      | L x W x H (mm)  | L x W x H (mm)  | Order Ref  | Price (Per Pack) |
|------------------|-----------------|-----------------|------------|------------------|
| Cargo Box Plus S | 400 x 320 x 320 | 410 x 330 x 340 | 012478S/20 | £110.00          |
| Cargo Box Plus X | 660 x 350 x 360 | 670x 360 x 380  | 012478X/20 | £133.00          |

### Counter Roll Holders

- Universal Multi positional Roll Holder.
- Can be used on a bench, under a bench or wall mounted
- Comes supplied with all necessary fixings
- High quality metal construction with plastic parts
- 4 sizes available: 500mm, 600mm, 750mm and 900mm



| Description               | Order Ref | Price (Each) |
|---------------------------|-----------|--------------|
| 500mm Counter Roll Holder | 012479    | £94.00       |
| 600mm Counter Roll Holder | 012480    | £102.00      |
| 750mm Counter Roll Holder | 012481    | £108.00      |
| 900mm Counter Roll Holder | 012482    | £113.00      |